

Fertilisation



SULKY 
FARMING TOGETHER

- DX** 
- X** 
- XT** 



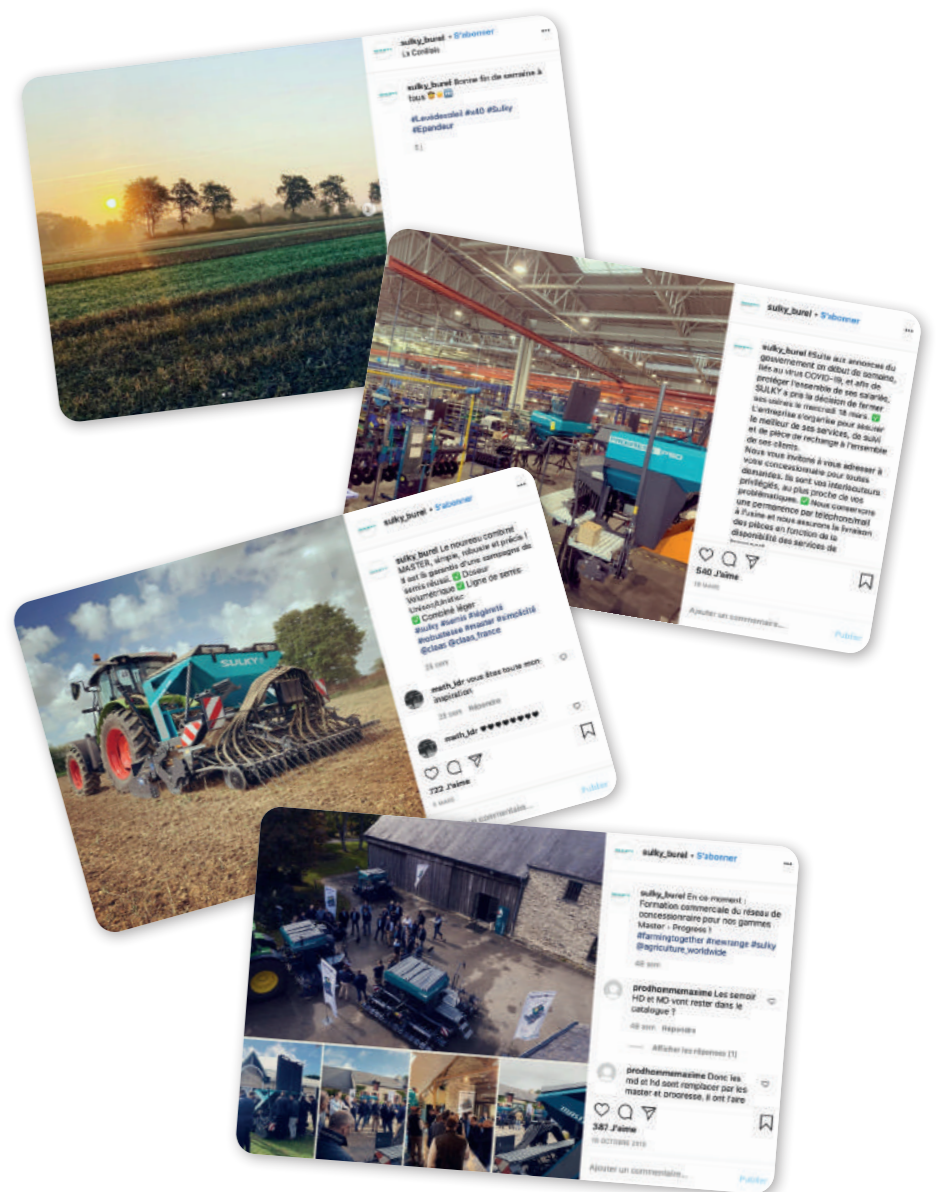
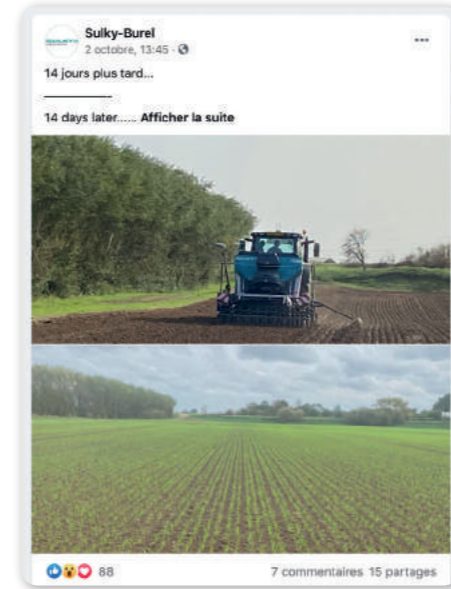
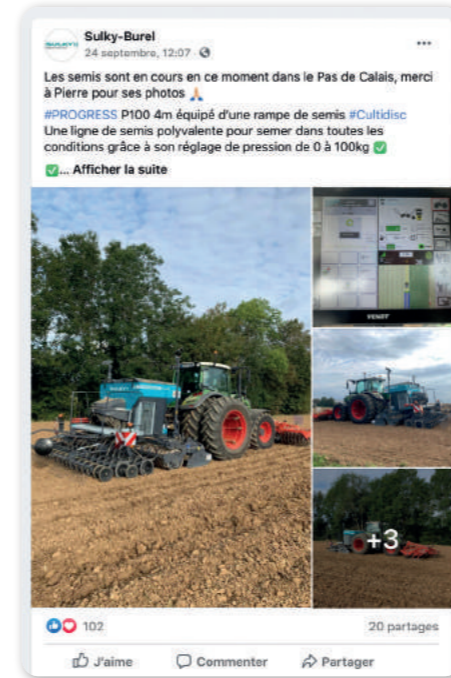





La Conillais





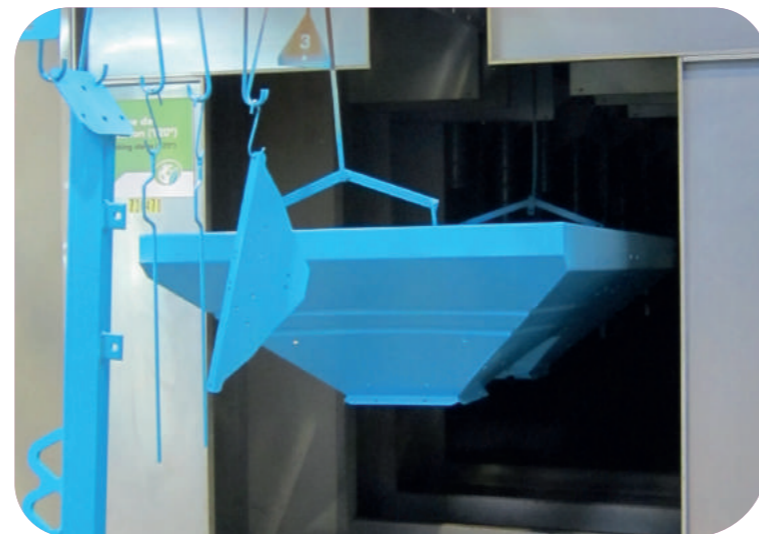
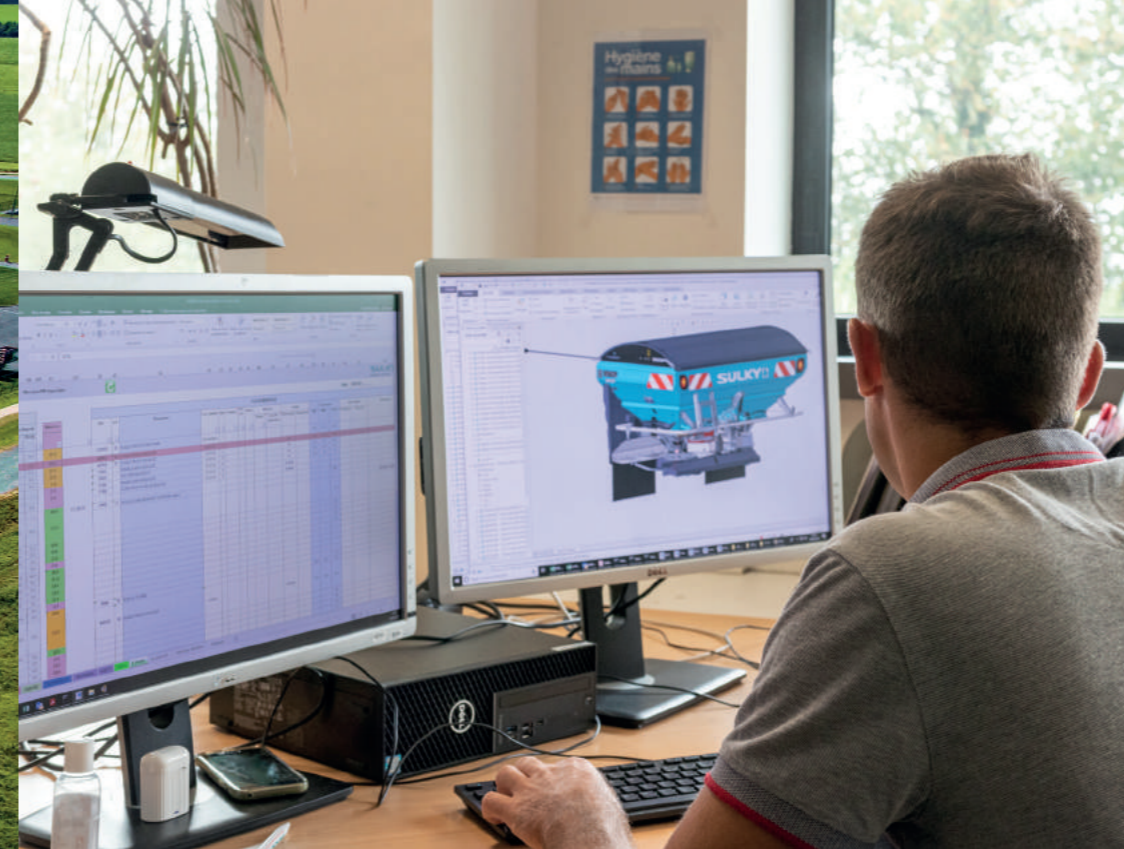





1949 - Super Sulky



2003 - DPX Magnum



1959 - Sulky Rotor



2005 - Polyvrac DPA



1986 - DPX



2016 - ECONOV



1991 - DPA-XL



2020

FERTITEST

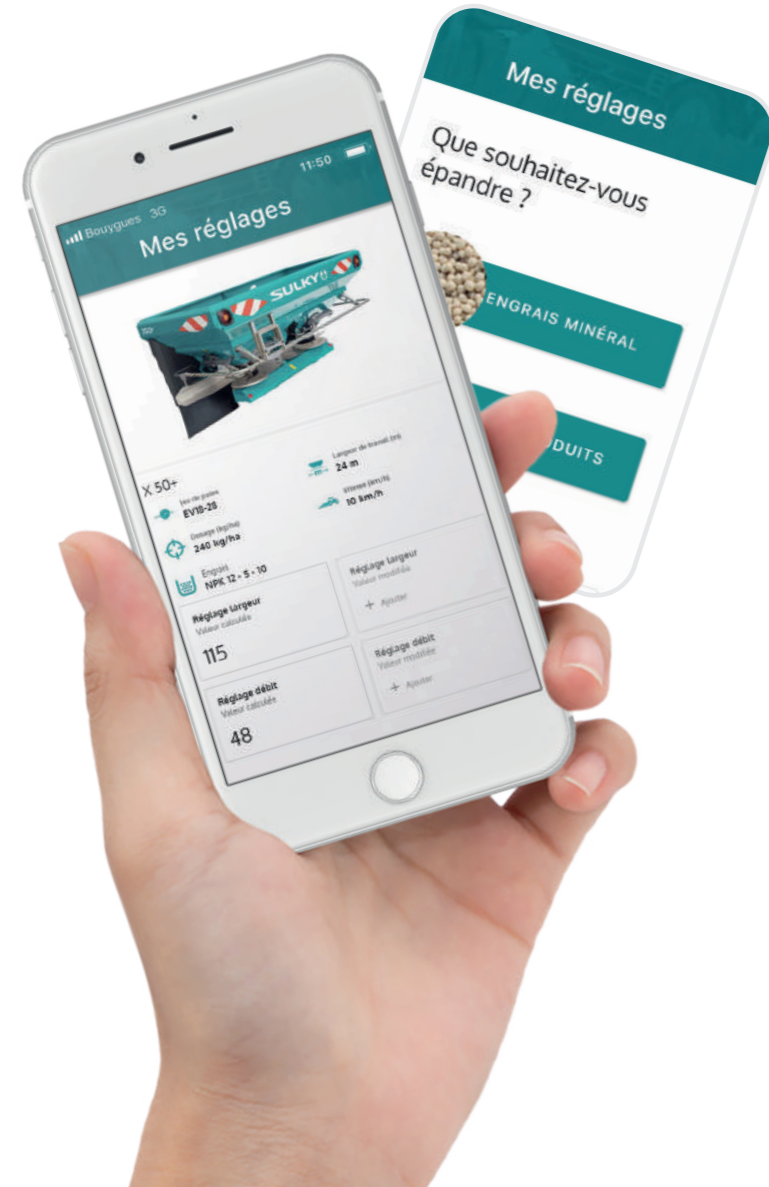

DX



DX 20 / DX 20+ 900L

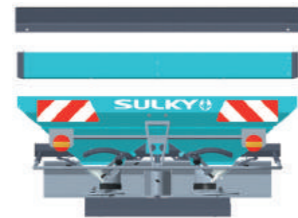

DX 20 / DX 20+ 1500L

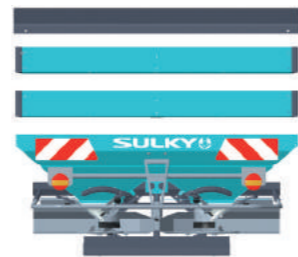

DX 20+ 2100L

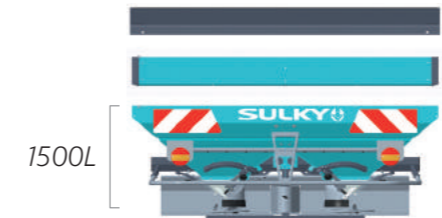

DX 30+ 1500L / 2150L



DX 30+ 2350L

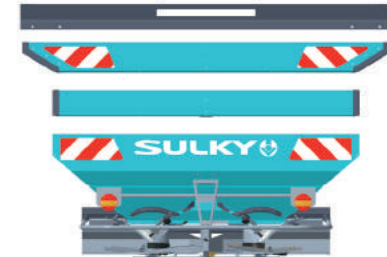

DX 30+ 3000L

X



X 40+

2050L

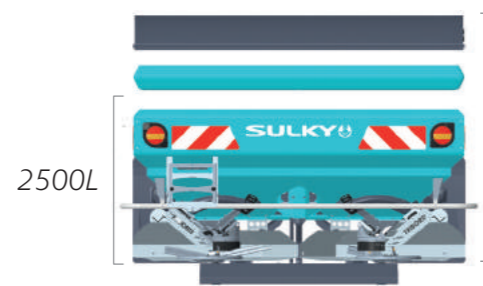

X 40+

2500L

2650L

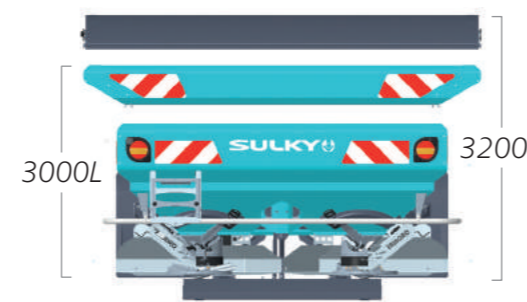

X 40+

3000L

3200L



X 50+

2600L

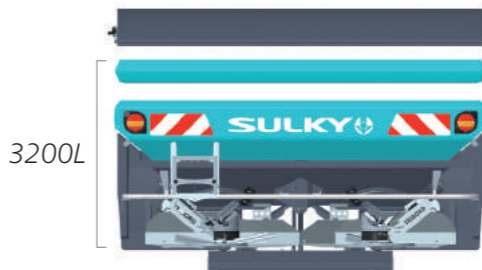

X 50+

3200L

3400L

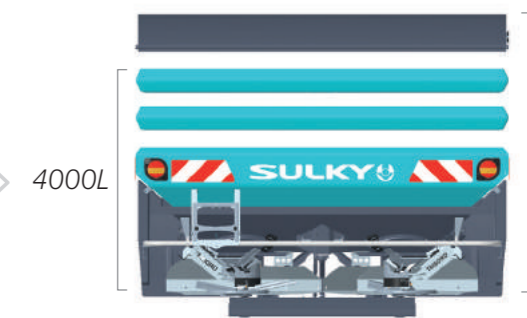

X 50+

4000L

4200L

XT

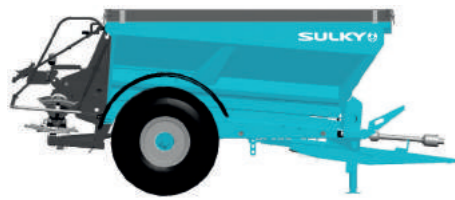

XT 100 7200L 10.0t

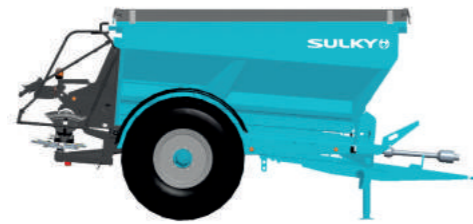

XT 130 9500L 12.5t



XT 160 13000L 15.9t

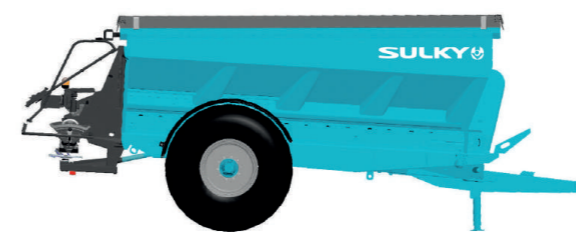

XT 160H 13000L 15.9t



XT 210H 13000L 20.5t



XT 240H 15500L 23.9t



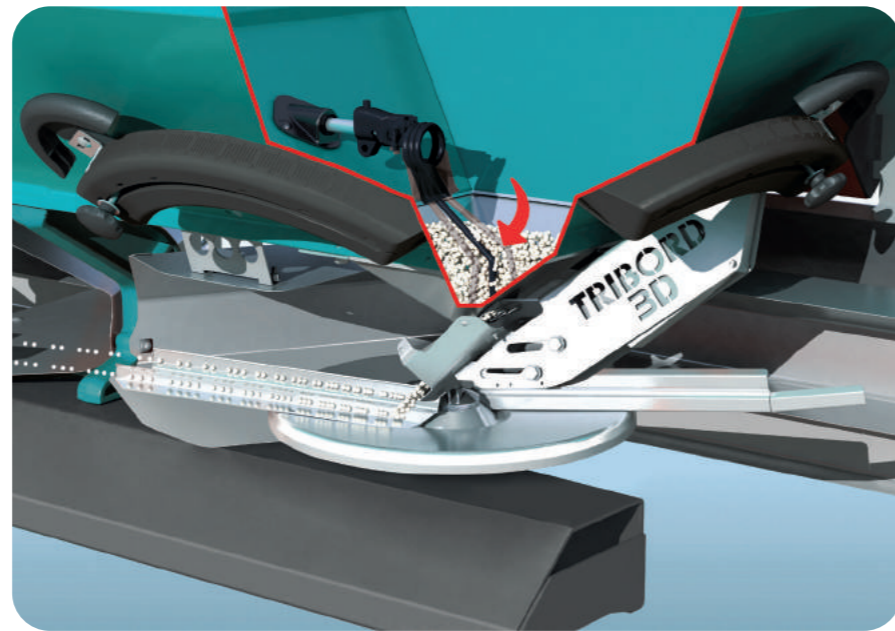
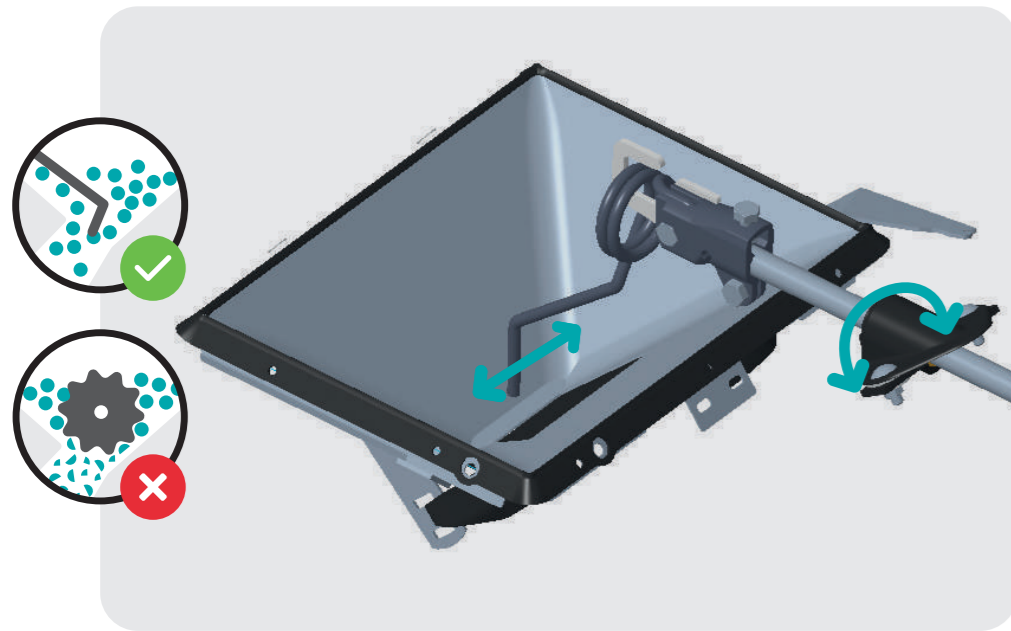
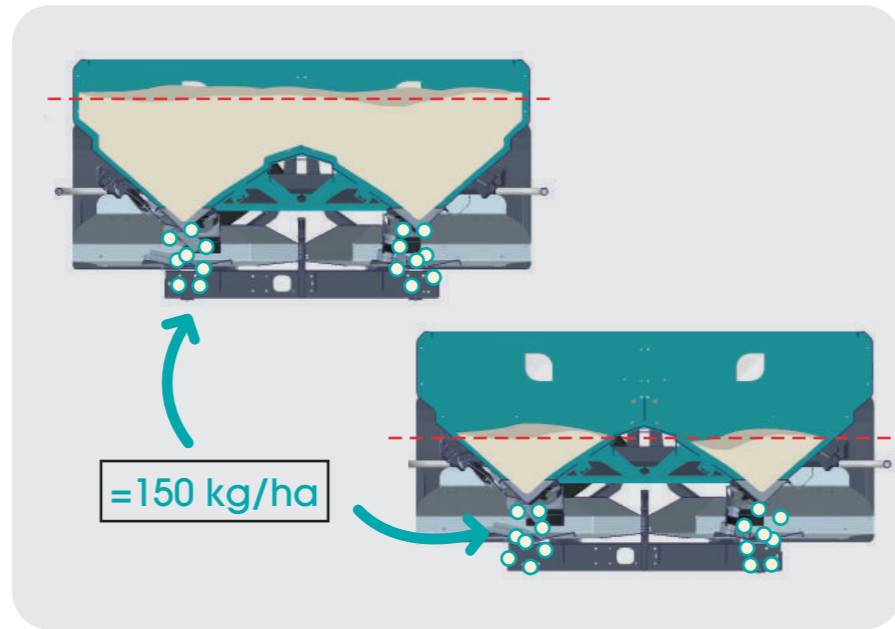
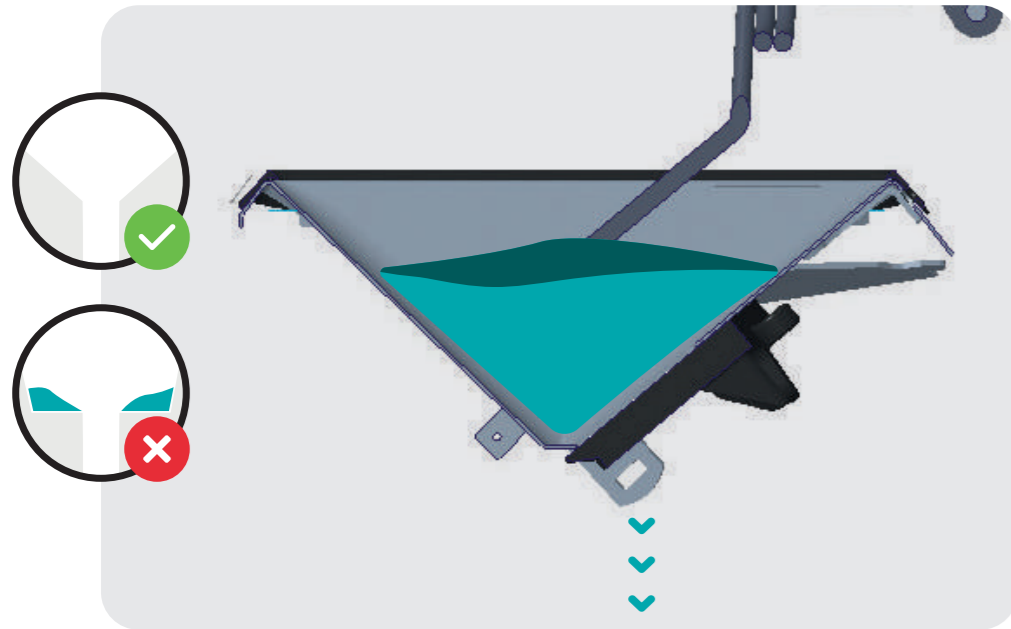

EPSILON
SYSTEM®

**PATENTED
SULKY**



FERTIWAY

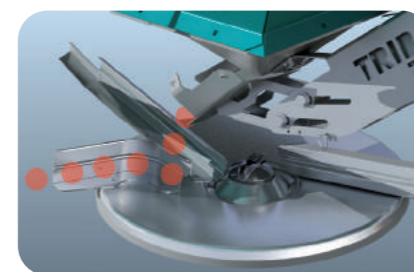
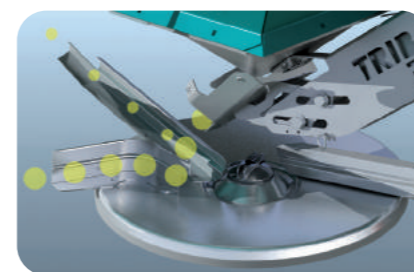
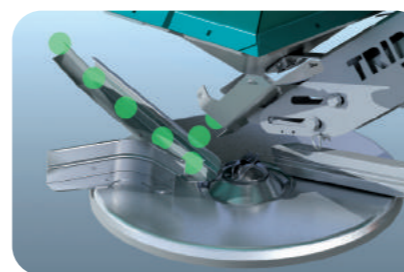
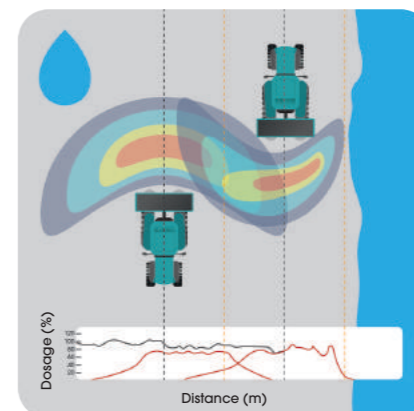
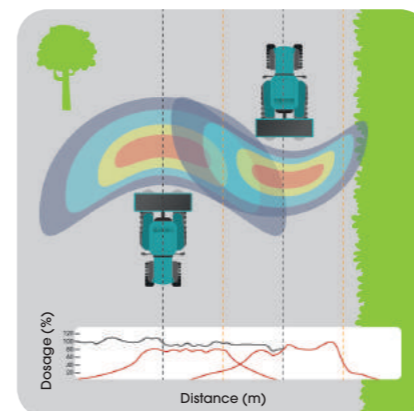
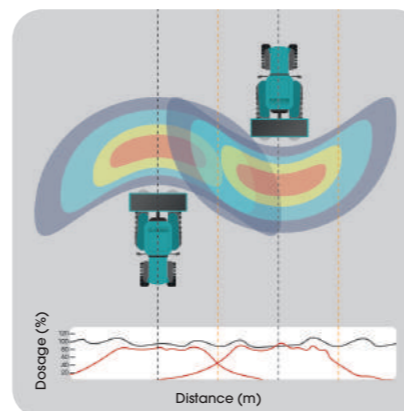
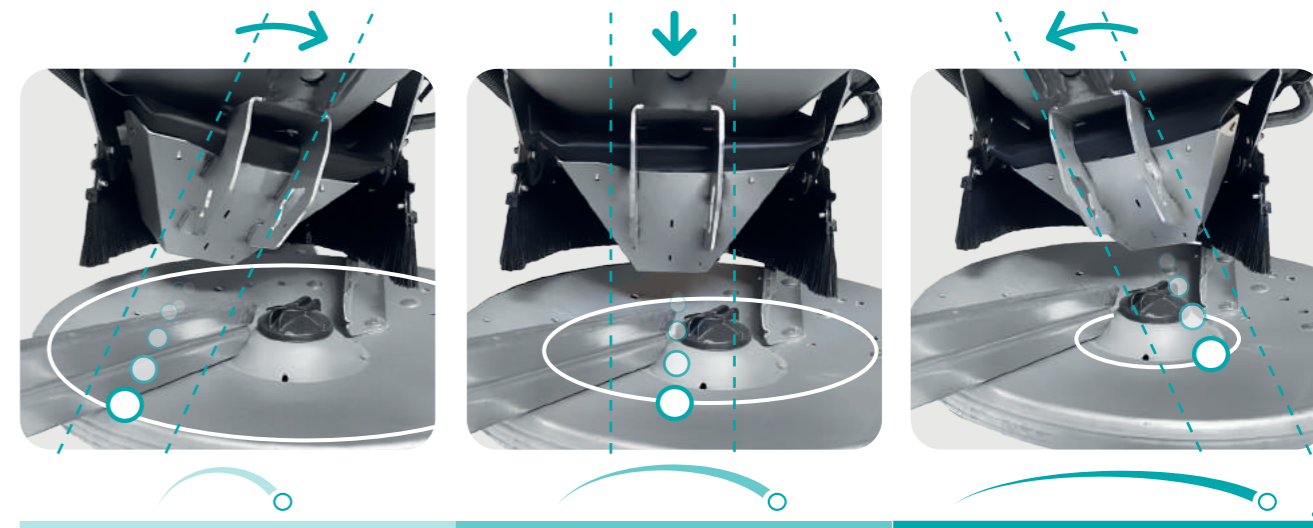

**PATENTED
SULKY**
**TRIBORD
3D
X & XT**



*DX = TRIBORD 2D





DX 30



HYDRAULIC



ELECTRIC



VISION DPB / WPB



W-VISION



W-CONTROL



W-ISOBUS



W-CONTROL ISOBUS

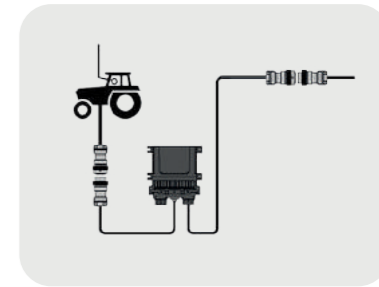

ISOLINK

W-CONTROL



ISO:ITS

ECONOV



PATENTED
SULKY

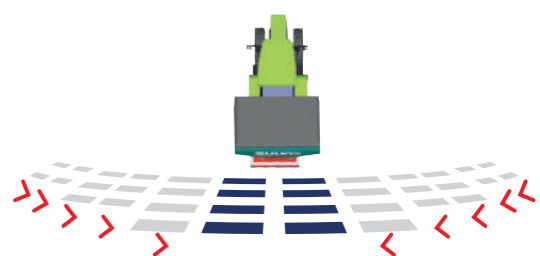
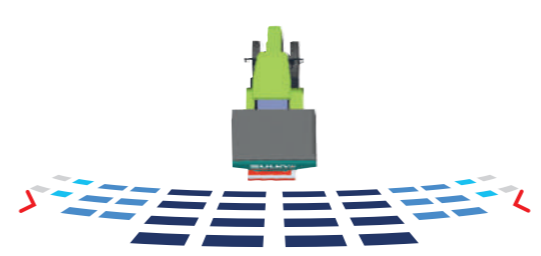
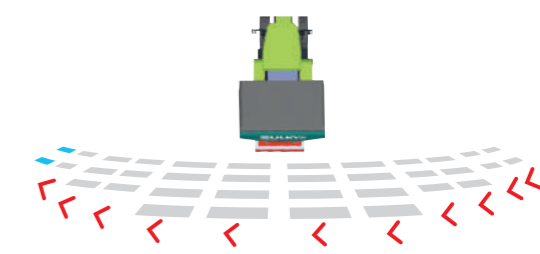
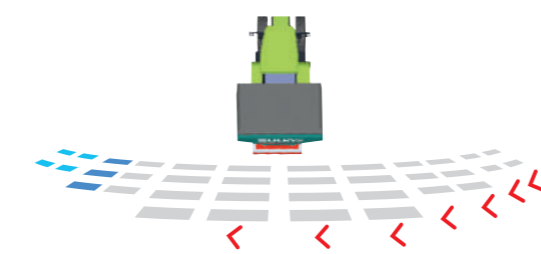
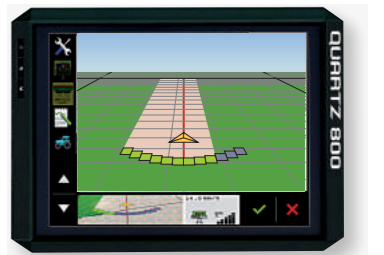
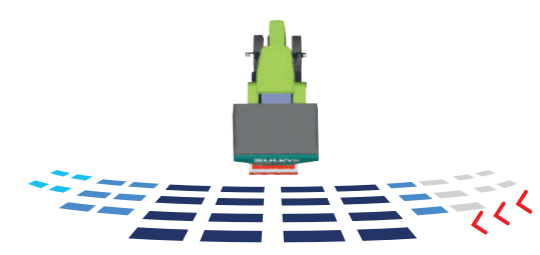
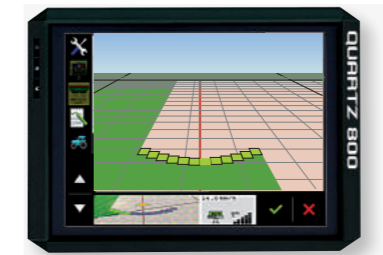
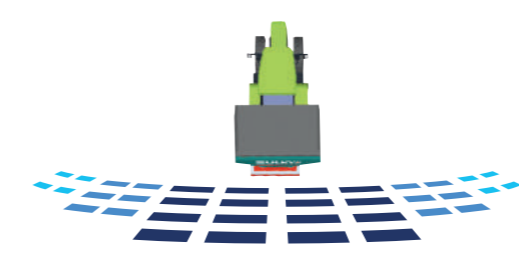





X 40+



**X 40+
Vision W**



**X 40+ / X 50+
Quartz W Econov**

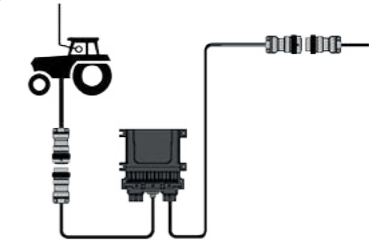

**X 40+ / X 50+
W Econov**

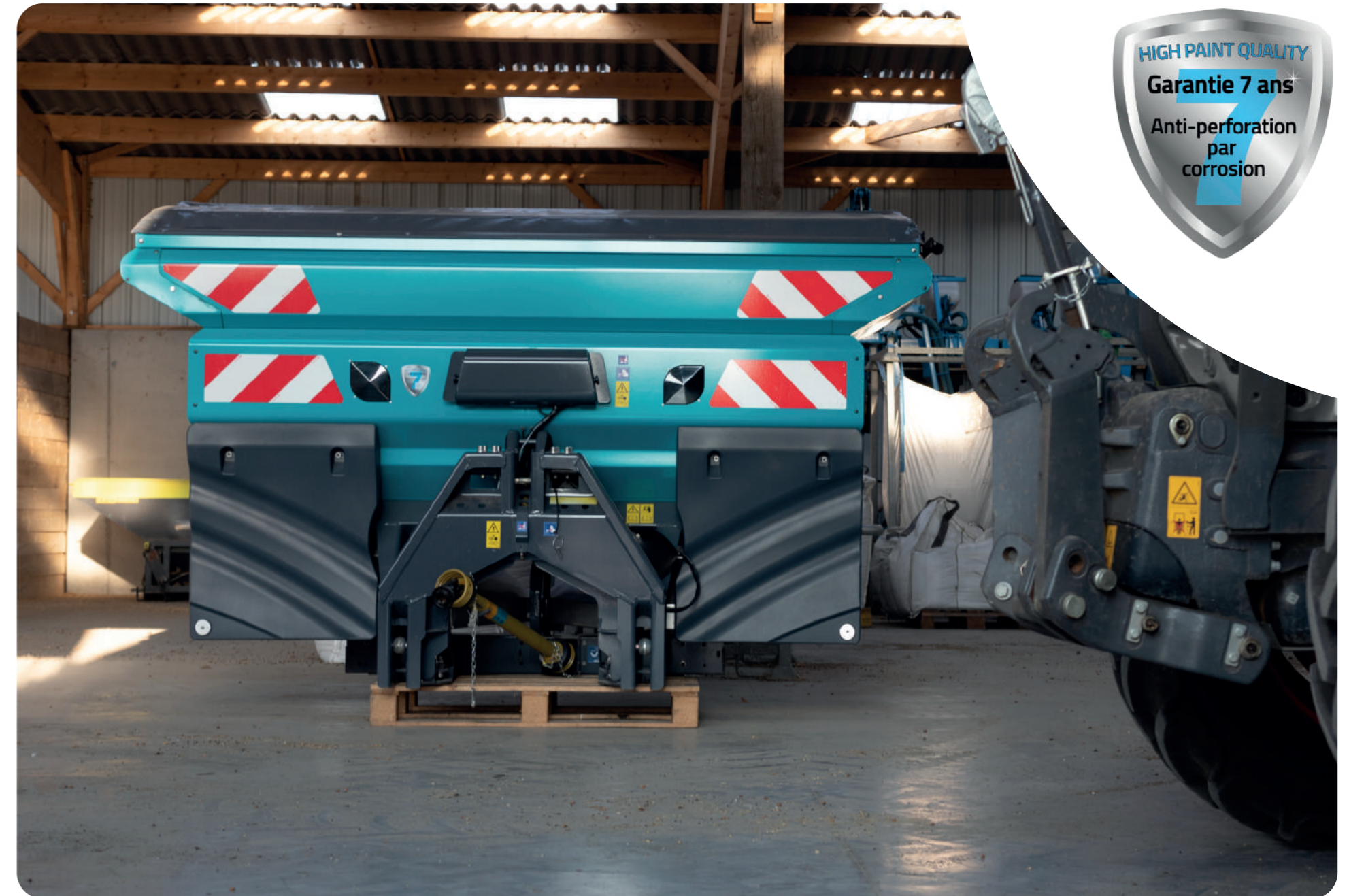

HIGH PAINT QUALITY

Garantie 7 ans

Anti-perforation
par
corrosion

DX 20 / DX 30

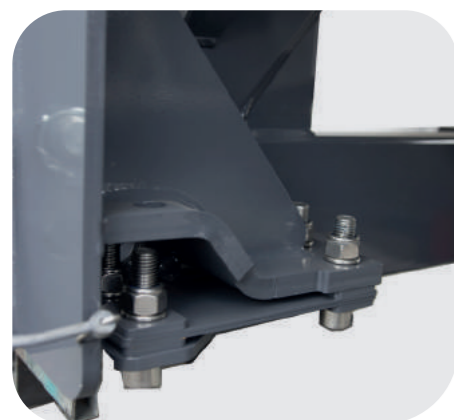

X 40+ / X 50+



OPTIONS



XT

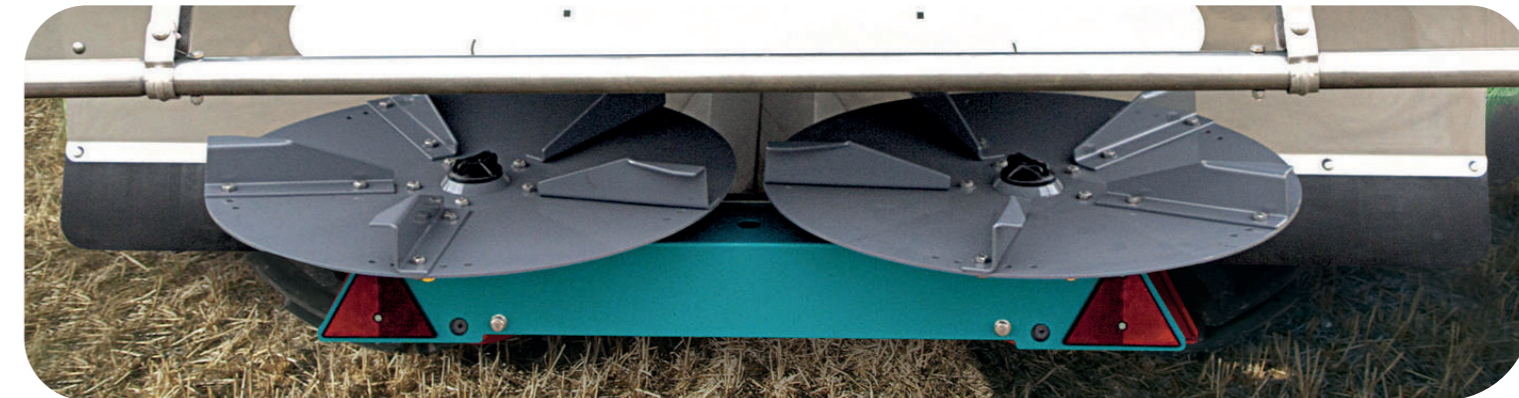
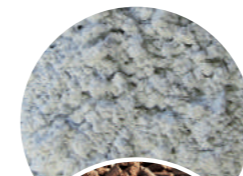

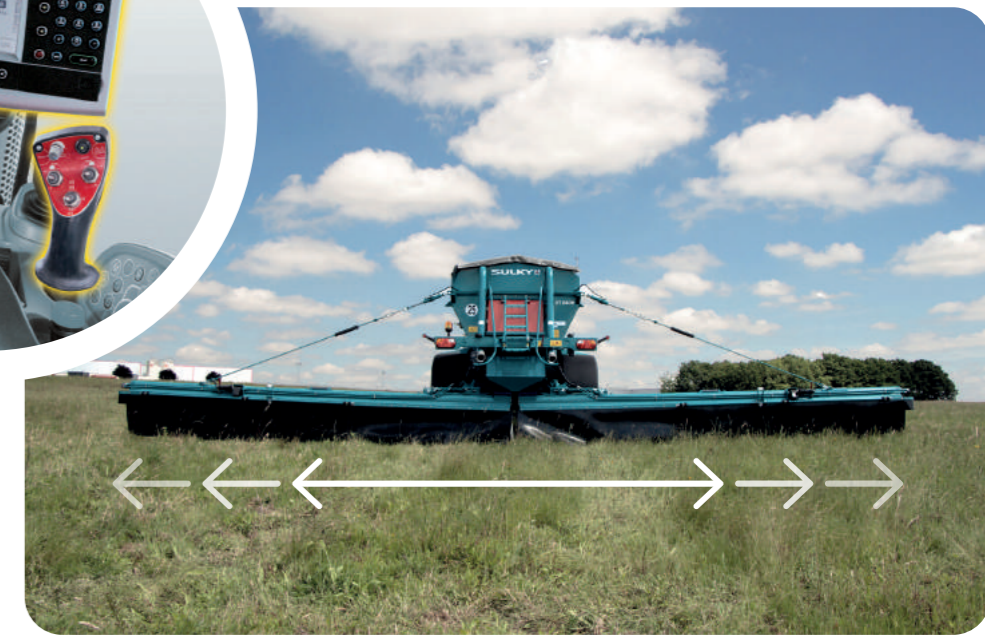
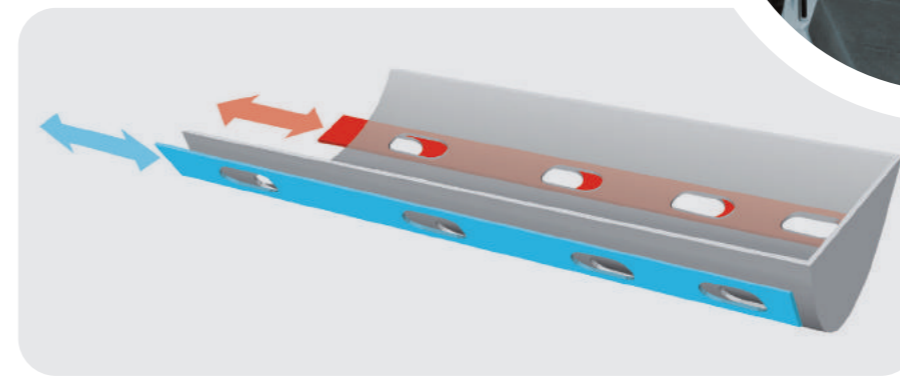
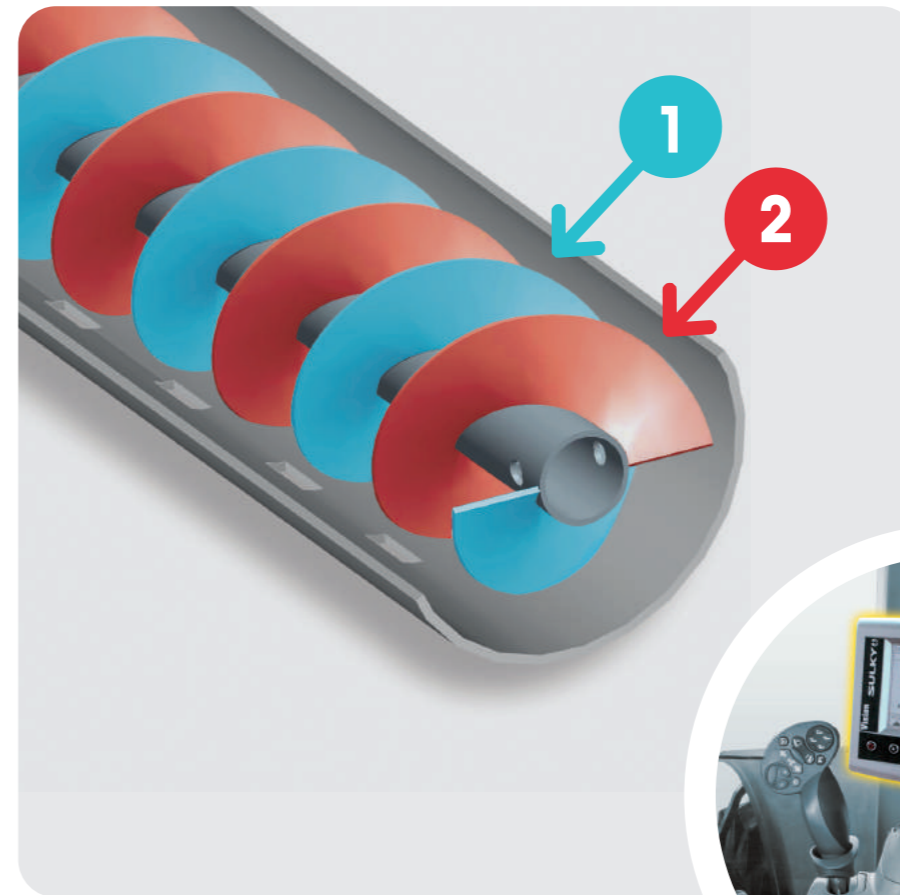
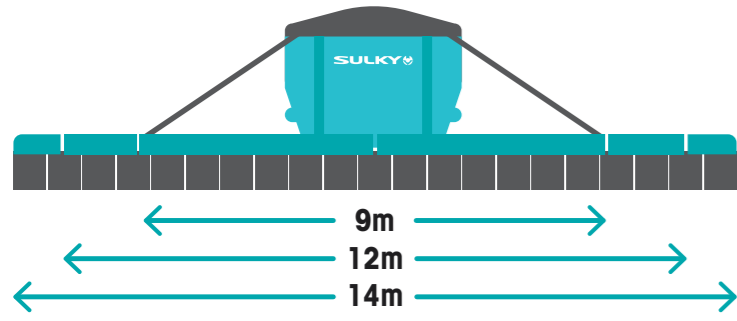



40km/h
(XT 130 - XT2 40)



25km/h

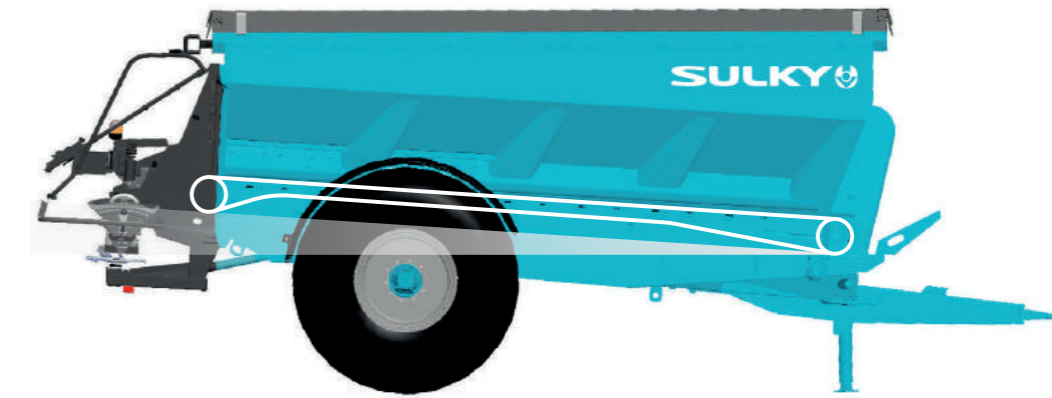

3°

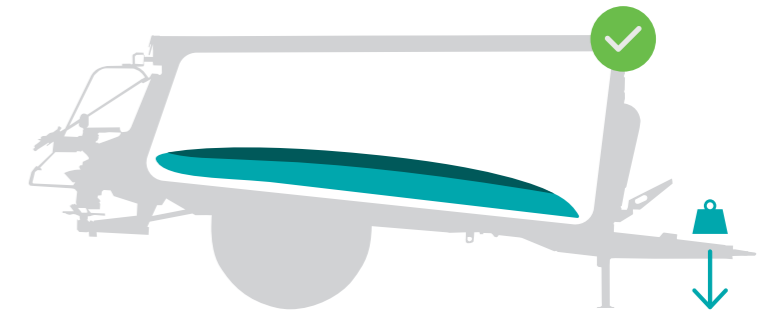
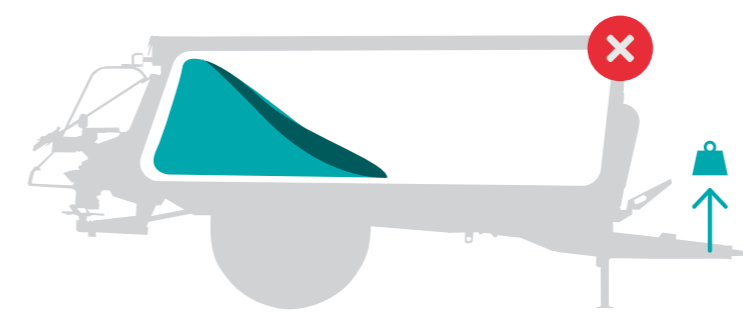



XT 100 / XT 130 / XT 160 / XT 160H / XT 210H / XT 240H

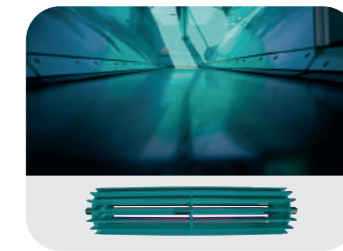
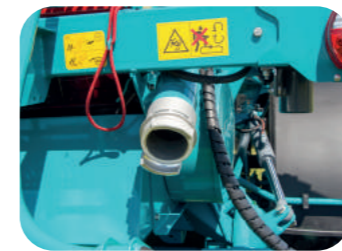
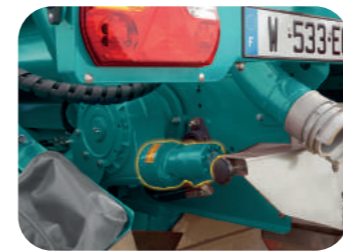
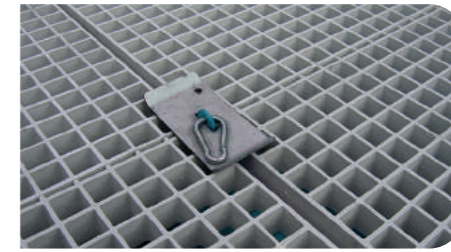
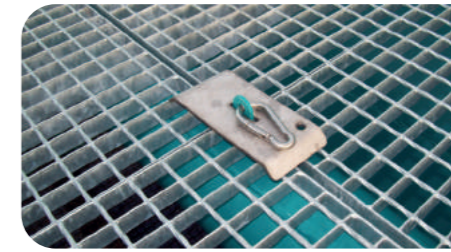

XT 160H / XT 210H / XT 240H

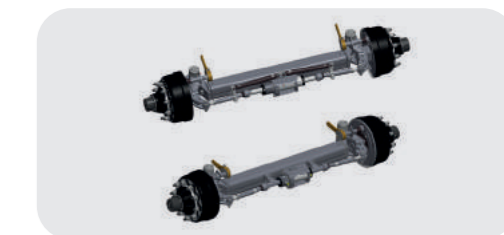

XT100



XT130



XT160 / XT160H



XT210H



XT240H



X 40+ / X 50+



Type	X 40+			X 50+		
	12 - 44 m			24 - 50 m		
	3000 kg			4000 kg		
	1900 / 2050 L	2500 / 2650 L	3000 / 3200 L	2400 / 2600 L	3200 / 3400 L	4000 / 4200 L
	2.70 m		2.98 m	2.98 m		
	2.31 m		2.81 m	2.81 m		
	1.23 m	1.41 m	1.52 m	1.26 m	1.44 m	1.62 m
	1.17 m			1.17 m		
	540 kg	570 kg	585 kg	565 kg	600 kg	635 kg

DX 20 / DX 30



Type	DX 20			DX 20+			DX 30+		
	9 - 18 m			12 - 24 m			12 - 36 m		
	1500 kg			2100 kg			3000 kg		
	900 L	1500 L	900 L	1500 L	2100 L	1500 L	2150 L	2350 L	3000 L
	2.29 m		2.29 m	2.48 m		2.98 m			
	1.23 x 2.21 m		1.23 x 2.21 m	1.23 x 2.40 m		1.23 x 2.80 m			
	0.91 m	1.12 m	0.91 m	1.12 m	1.32 m	1.06 m	1.27 m	1.29 m	1.49 m
	300 kg	340 kg	300 kg	345 kg	385 kg	305 kg	350 kg	355 kg	400 kg

XT / XTH



Type	XT 100	XT 130	XT 160	XT 160H	XT 210H	XT 240H
	10 000 kg	12 500 kg	15 900 kg	15 900 kg	20 900 kg	23 900 kg
	7200 L	9500 L	13000 L	13000 L		15500 L
	6.63 m			8.39 m		
	2.50 to 3.00 m			2.55 to 3.00 m		
	2.32 to 2.69 m	2.55 to 2.85 m	2.78 to 2.94	2.78 to 2.94 m	2.86 to 2.93 m	3.06 to 3.16 m
	4.00 x 2.06 m			5.35 x 2.06 m		
	80 to 100 cv	90 to 110 cv	120 to 140 cv	130 to 150 cv	140 to 180 cv	180 to 220 cv
	90 mm	100/130 mm	140 mm	140 mm	2 x 110 Boggie (rear fol.)	2 x 140 Tandem (rear fol.)
	18.4 x 30	23.1 x 26	600/60 x 30.5	600/60 x 30.5	600/55 x R 26.5	600/55 x R 26.5
	2500 kg	2800 kg	3900 kg	4900 kg	5900 kg	6900 kg





Fertilisation



Les Portes de Bretagne - P.A. de la Gaultière
35220 CHÂTEAUBOURG France
☎ +33 (0)2 99 00 84 84
info@sulky-burel.com

www.sulky-burel.com