



**PROGRESS**







Fontenay-sur-Eure



Carvin



Châteaubourg



La Conillais



Osasco









**WE ARE** energetic efficiency  
PRECISION **INDUSTRIAL**  
TECHNOLOGY







# FARMING TOGETHER

Be positive about Agriculture

*Positivez sur l'Agriculture*

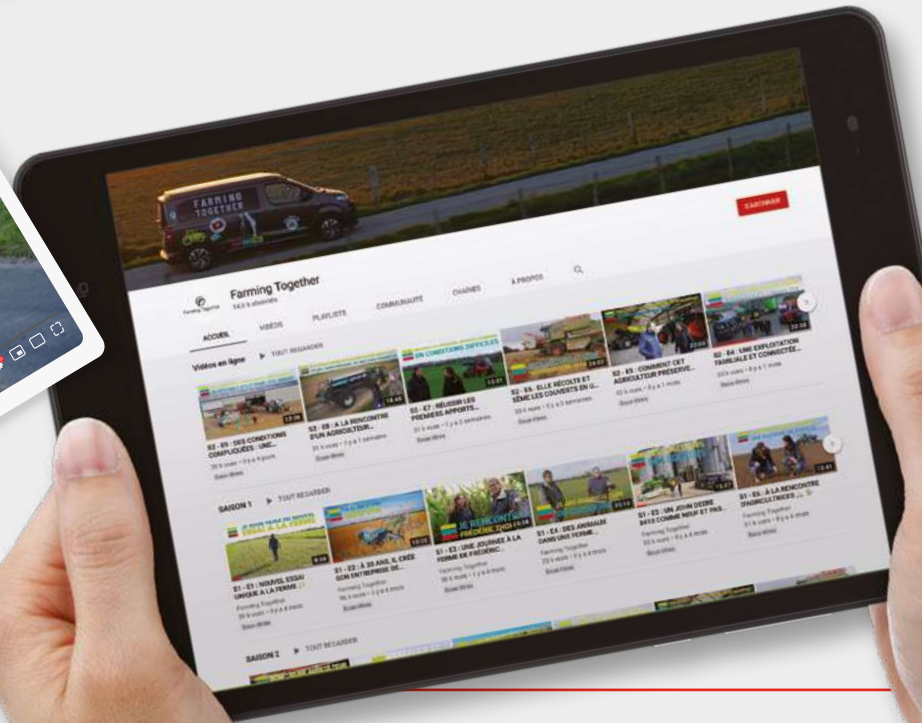
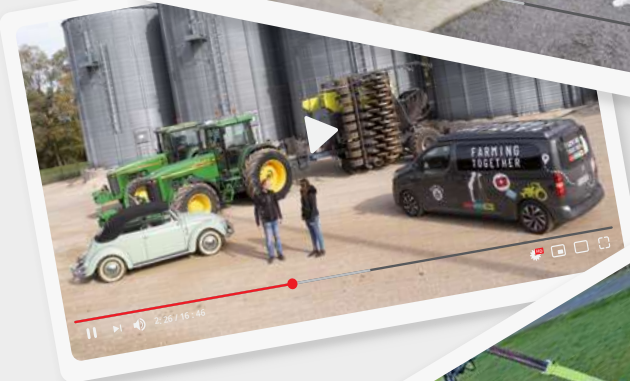
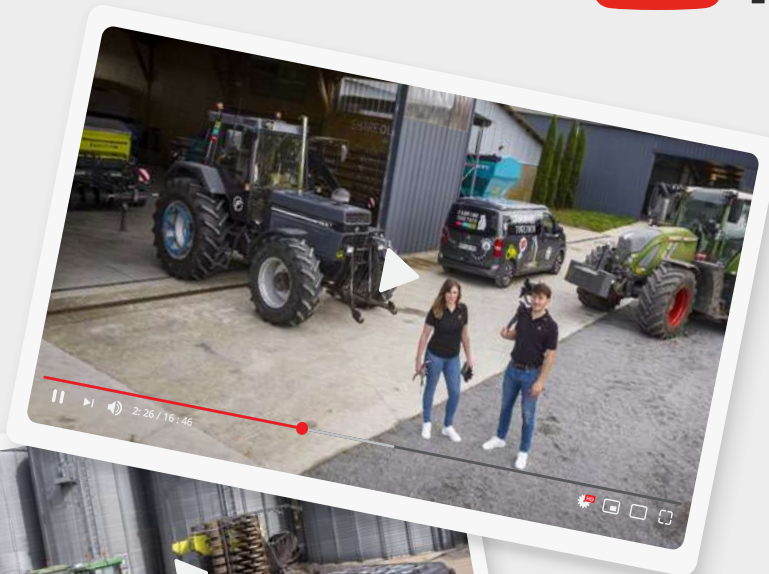





Softshell



Veste matelassée



[farming-together.com](https://farming-together.com)

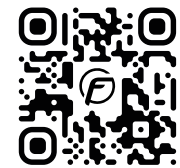





1936 - Super Sulky









## HR



**HR 160 / 3m**



**HR 190 / 3m**



**HR 220 / 3,5 - 4m**



**HR 300 / 3 - 3,5 - 4m**

## XR



**XR / 3 - 3,5 - 4m**

## Rolls



**Cage** Ø500 mm



**Farmflex** Ø520 mm



**Packer** Ø550 mm



**Tracker** Ø550 mm

## Seeding line



**P20**



**P30**



**P50**



**P100**



## PROGRESS M



1000L



1250L



1250L + 100L



1750L



1750L + 100L



1200L + 800L



1200L + 800L + 100L

	PROGRESS M	PROGRESS
<b>P20</b>	✓	✓
<b>P30</b>	✓	
<b>P50</b>		✓
<b>P100</b>		✓

## PROGRESS

PROGRESS M	Pilot
<b>PROGRESS</b>	Isobus
	E-Drive
	TC-Geo
	TC-SC









**HR**

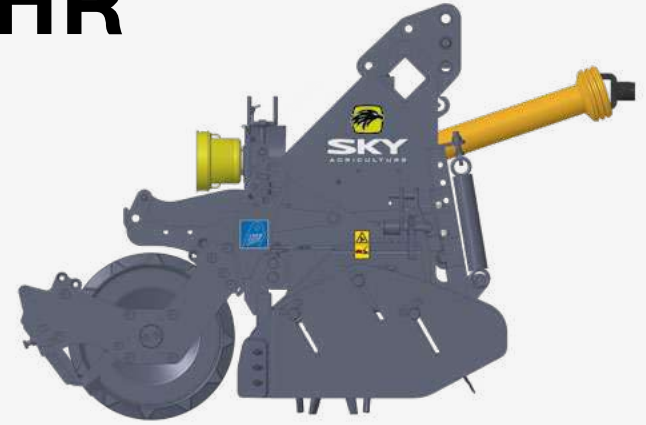

**XR**

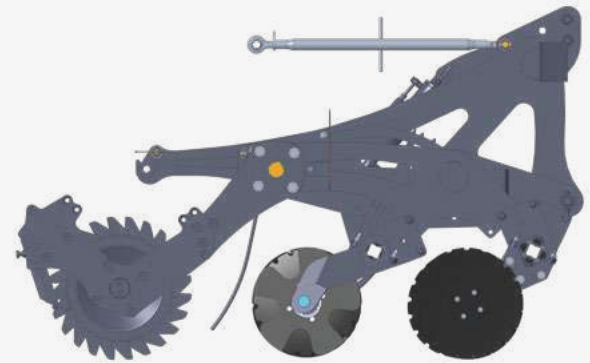







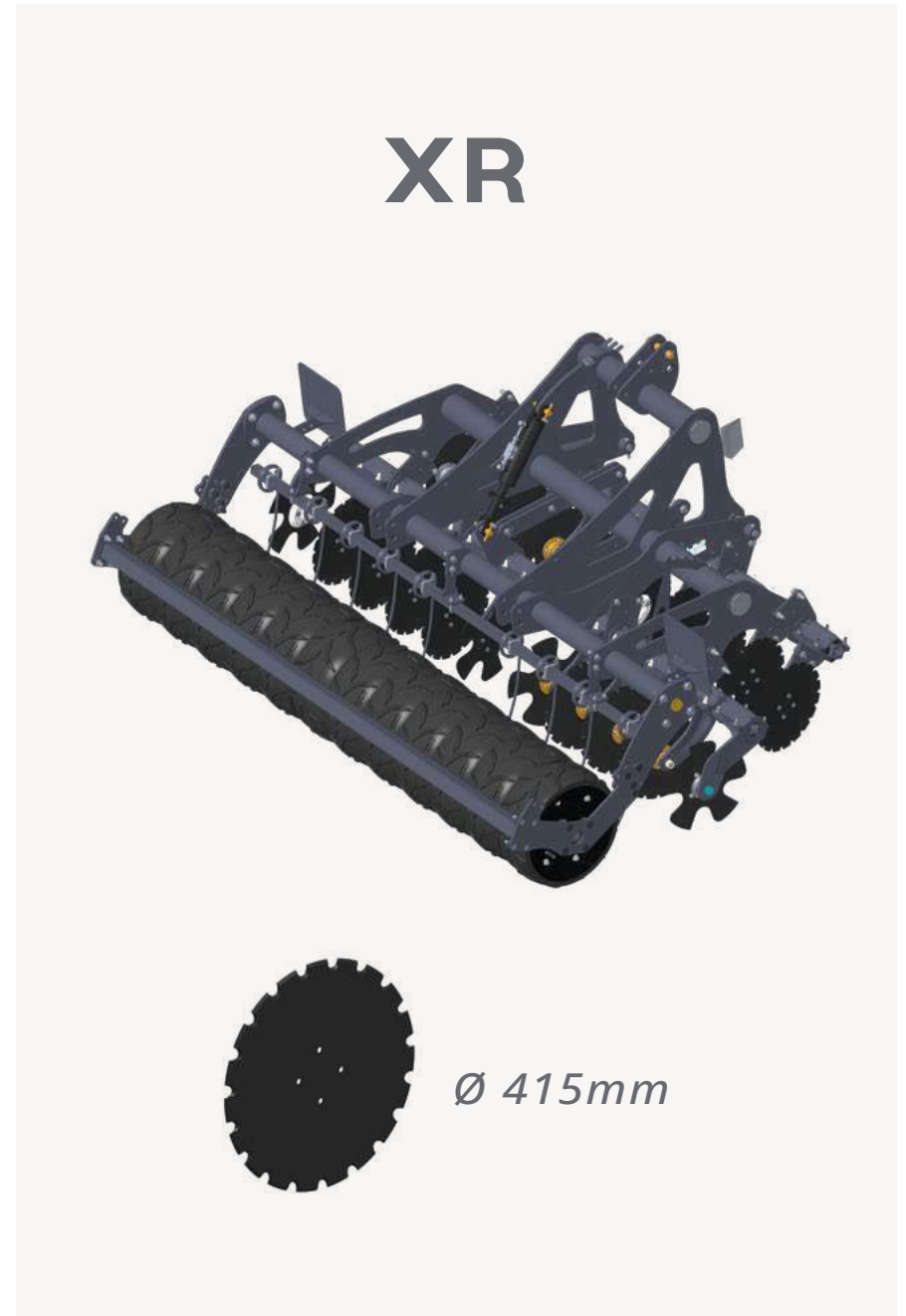



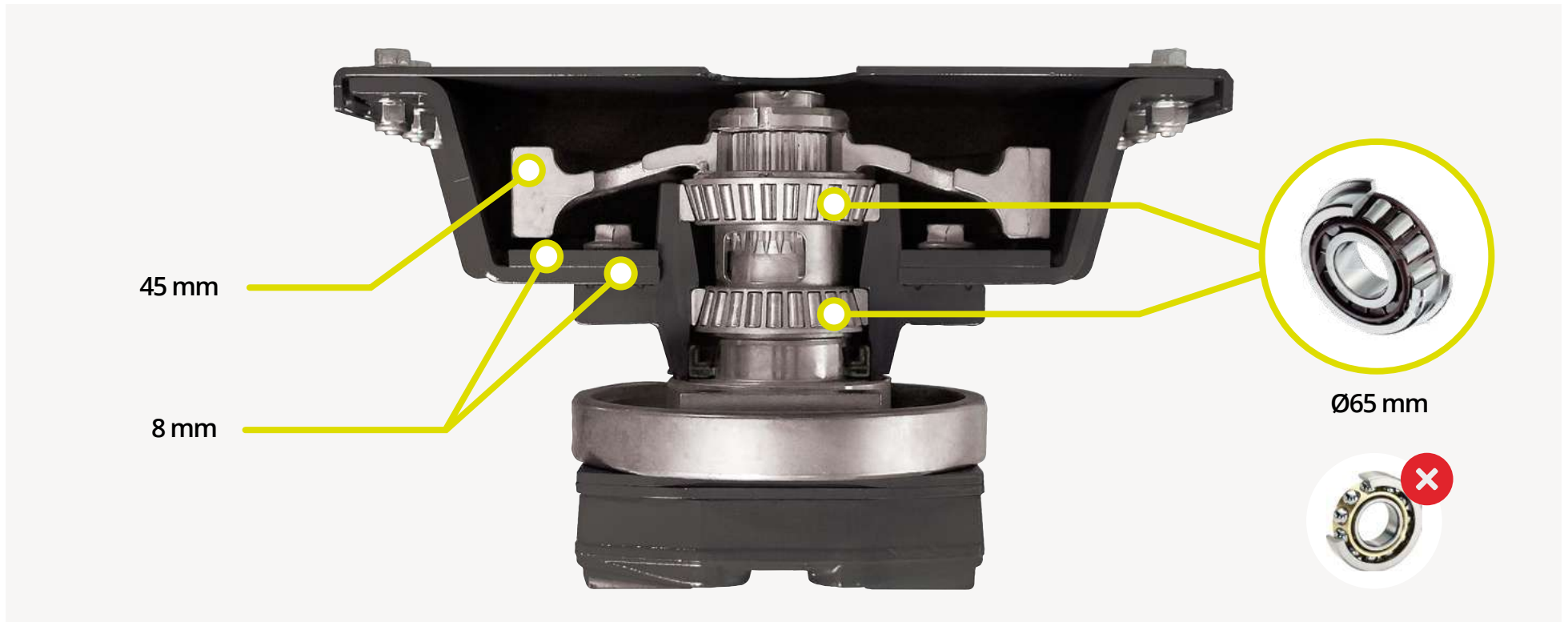



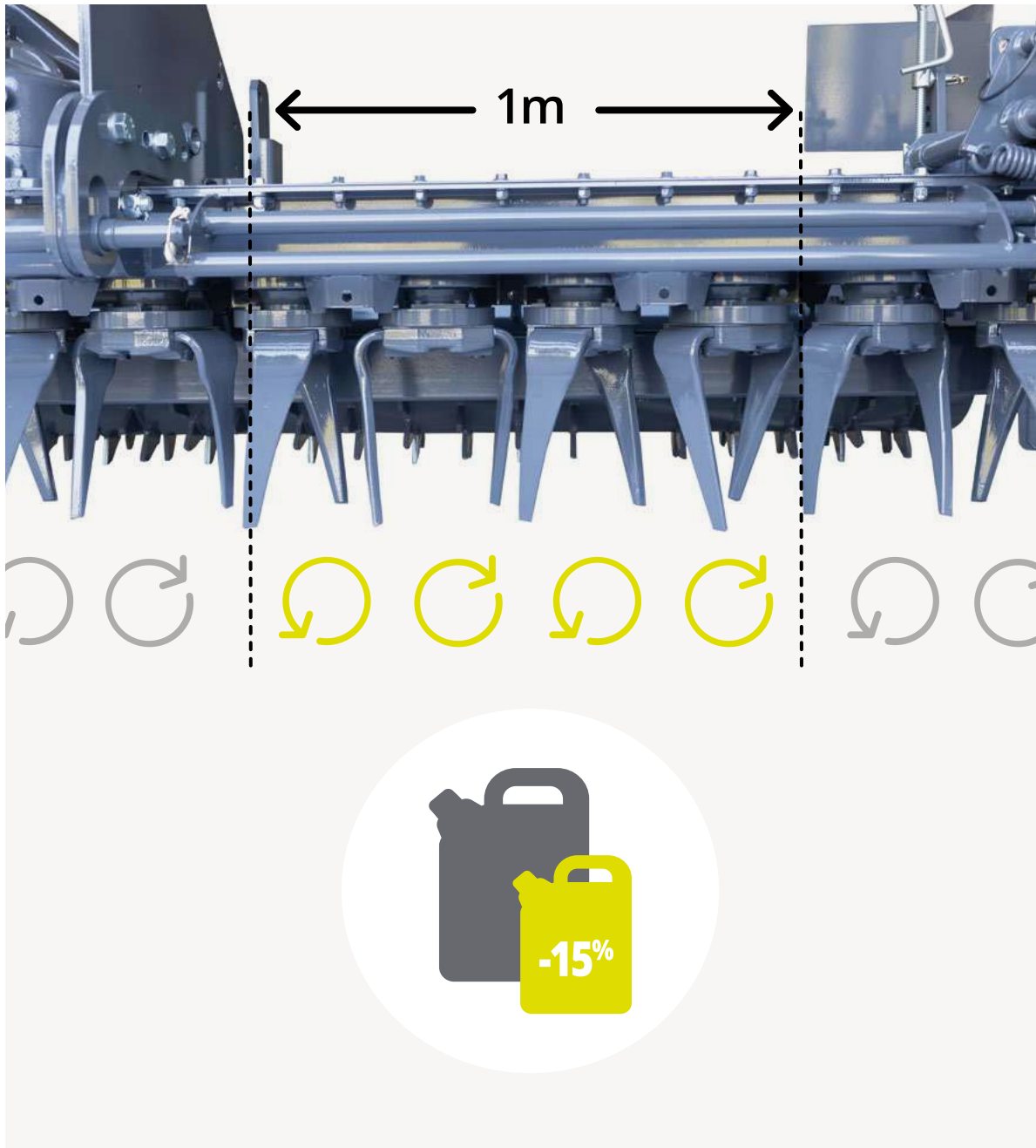







**Cage**  
Ø500 mm



**Farmflex**  
Ø520 mm



**Packer**  
Ø550 mm



**Tracker**  
Ø550 mm





# PROGRESS M





# PROGRESS





1

PROGRESS M

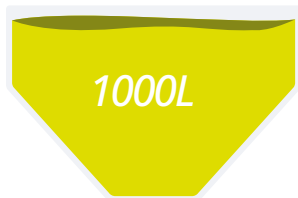

PROGRESS

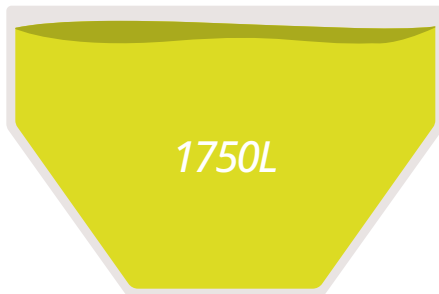
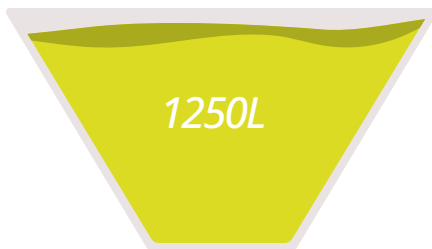

2

PROGRESS

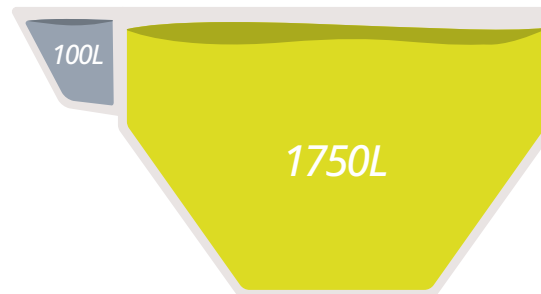
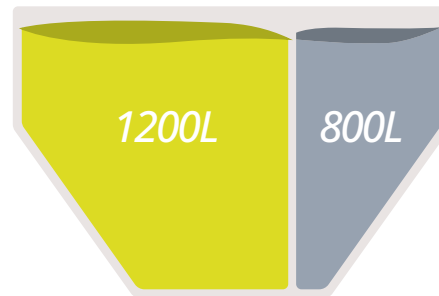
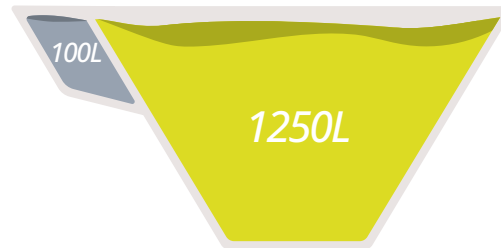

3

PROGRESS

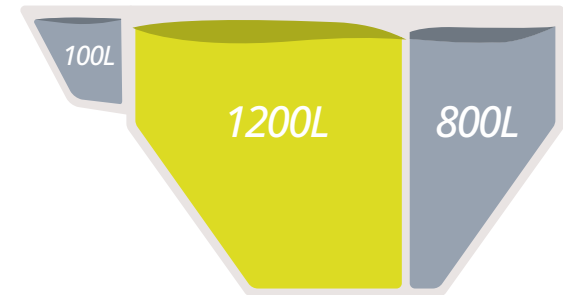







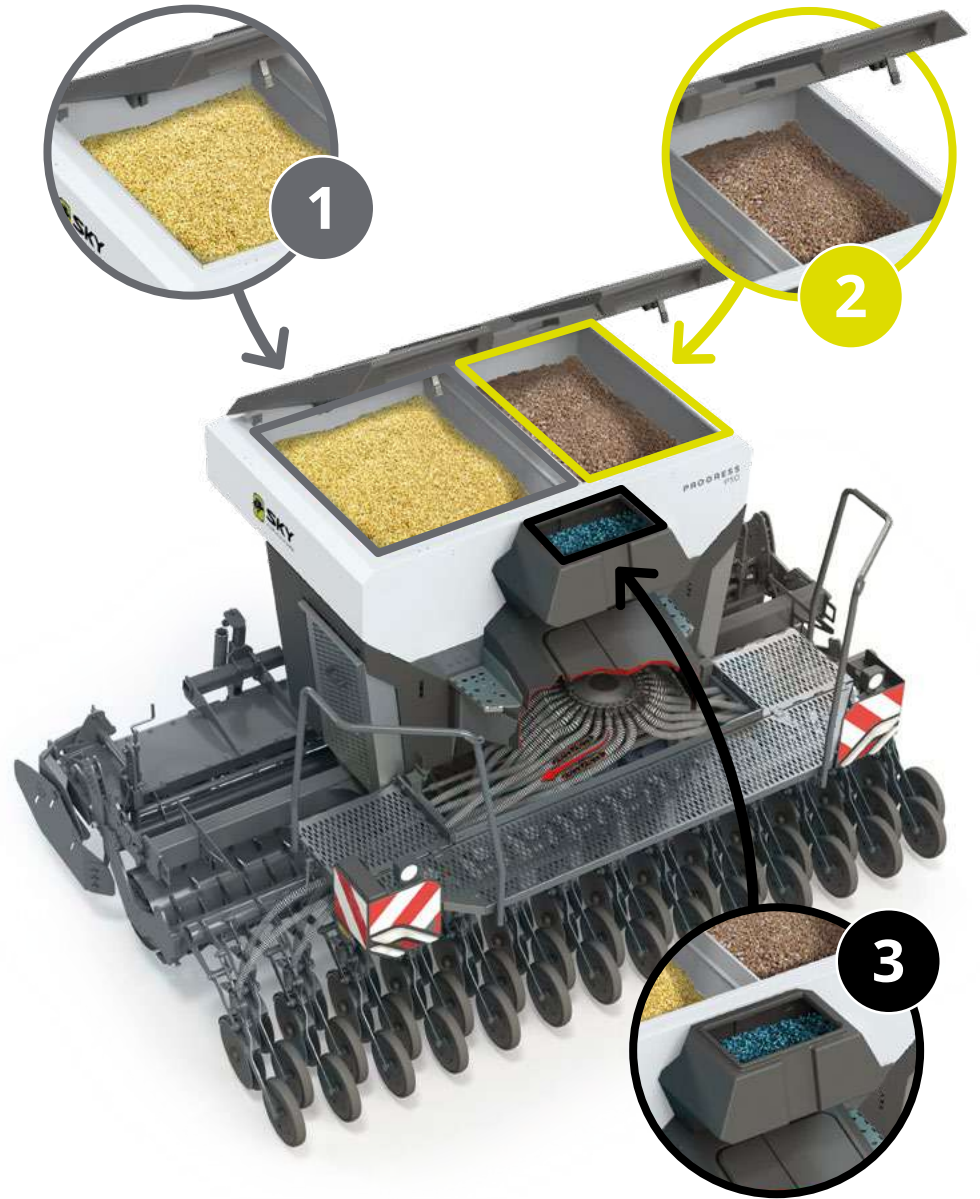



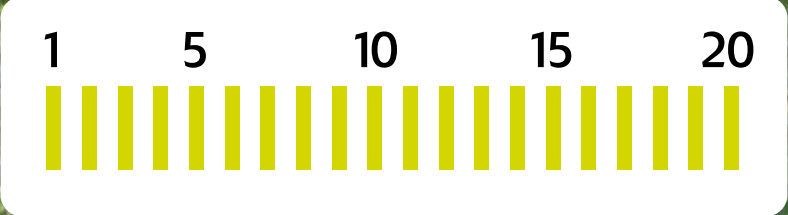



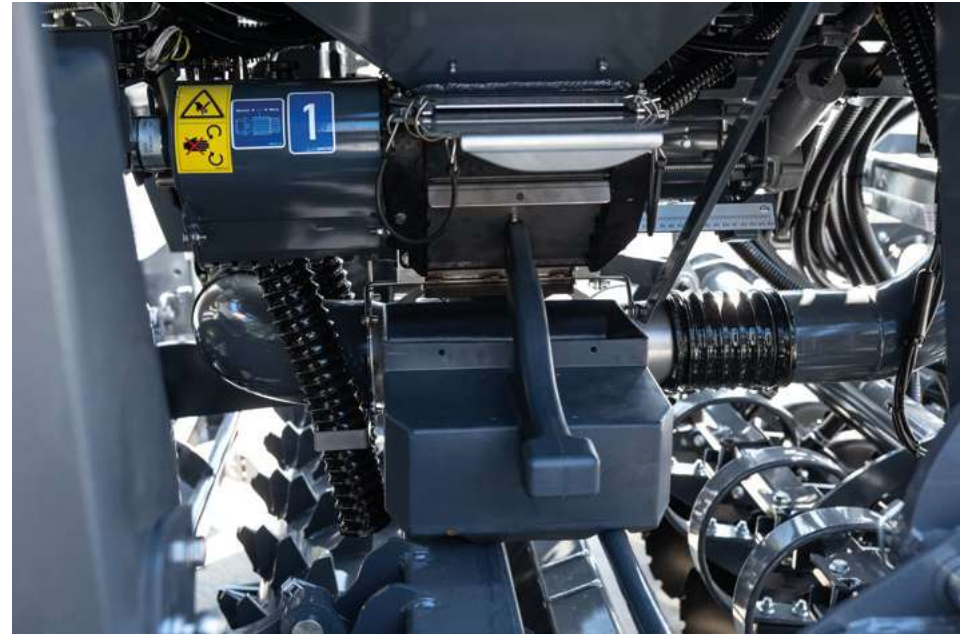
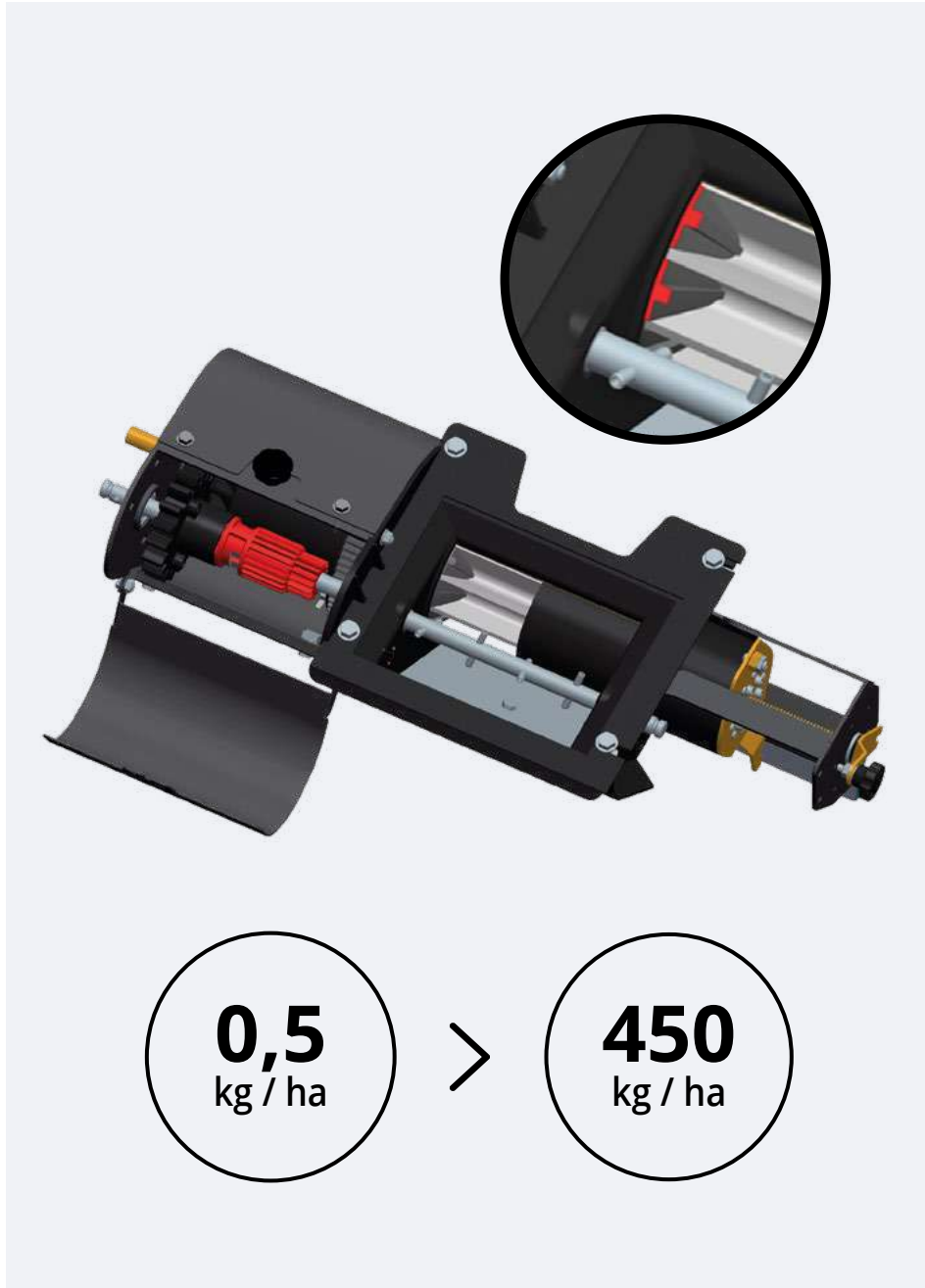



## PROGRESS M



## PROGRESS





# E-Drive







=





# E-Drive

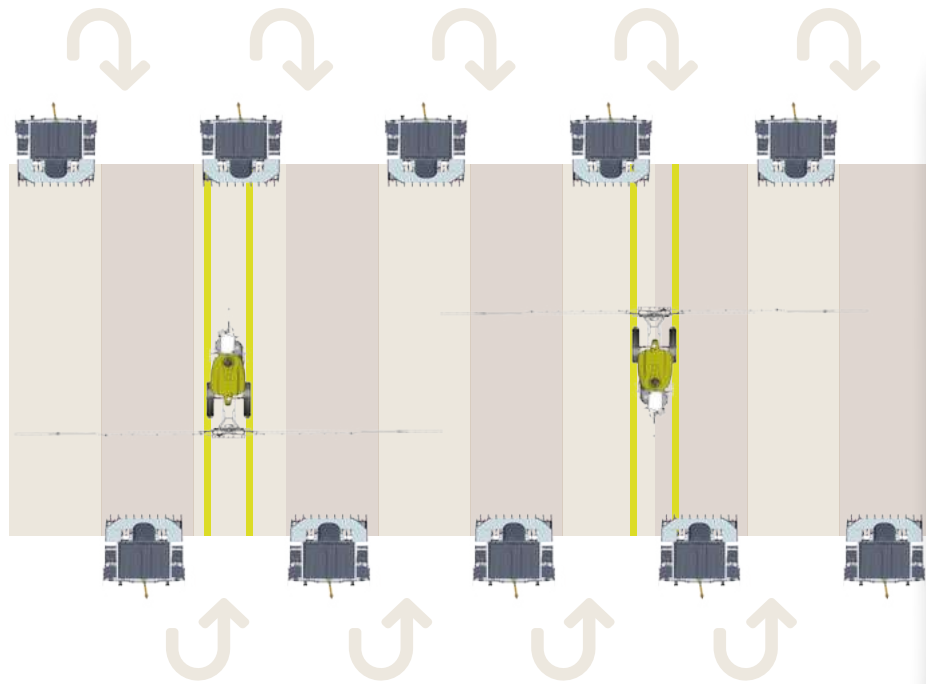



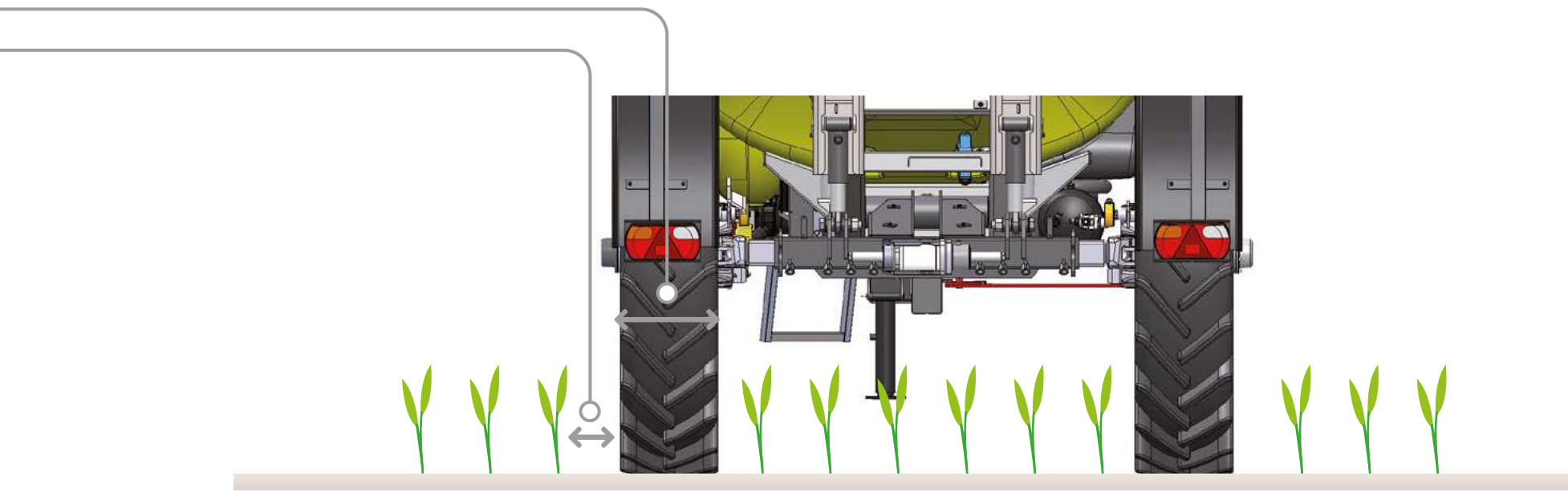
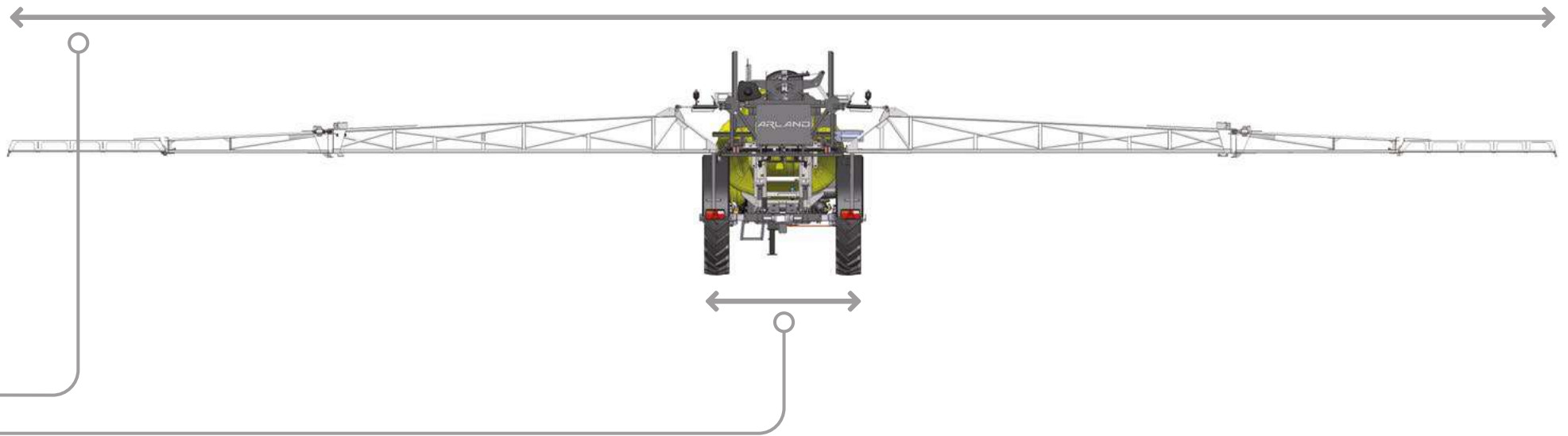



# E-Drive

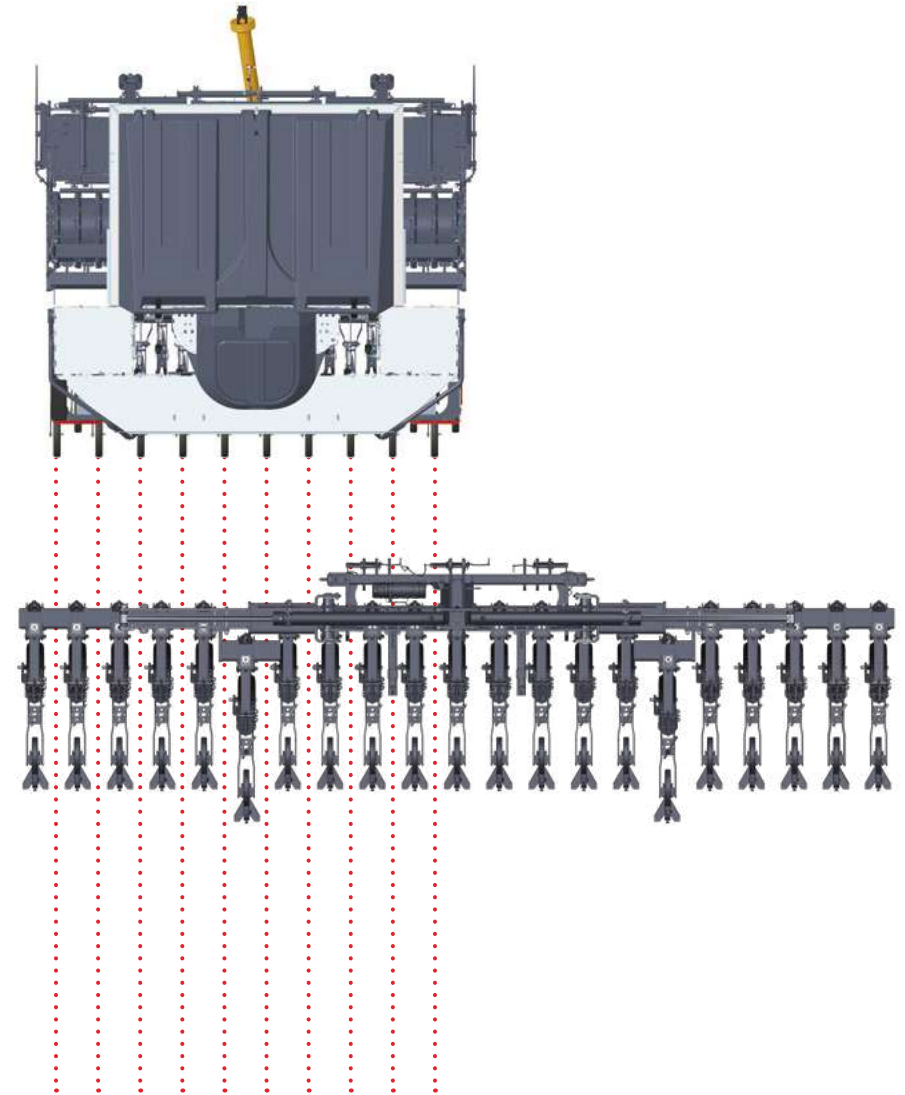



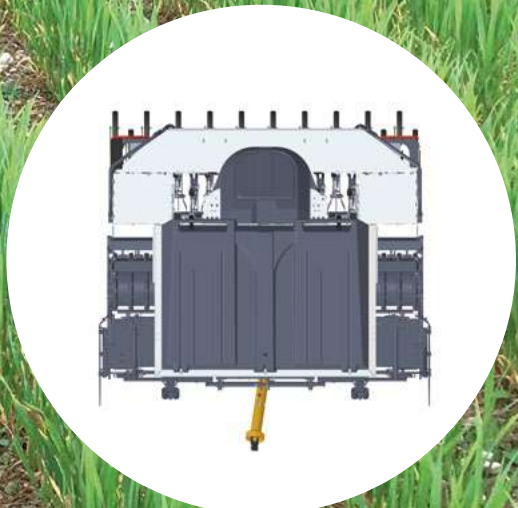
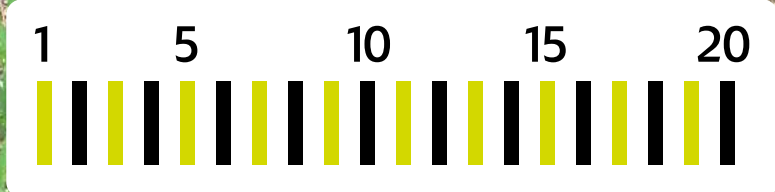
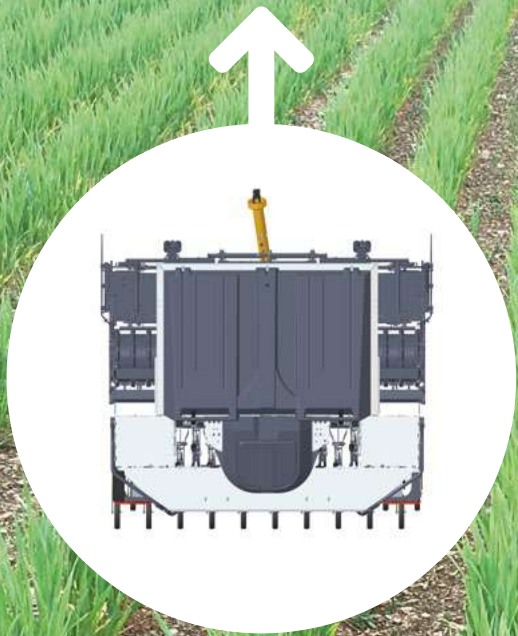
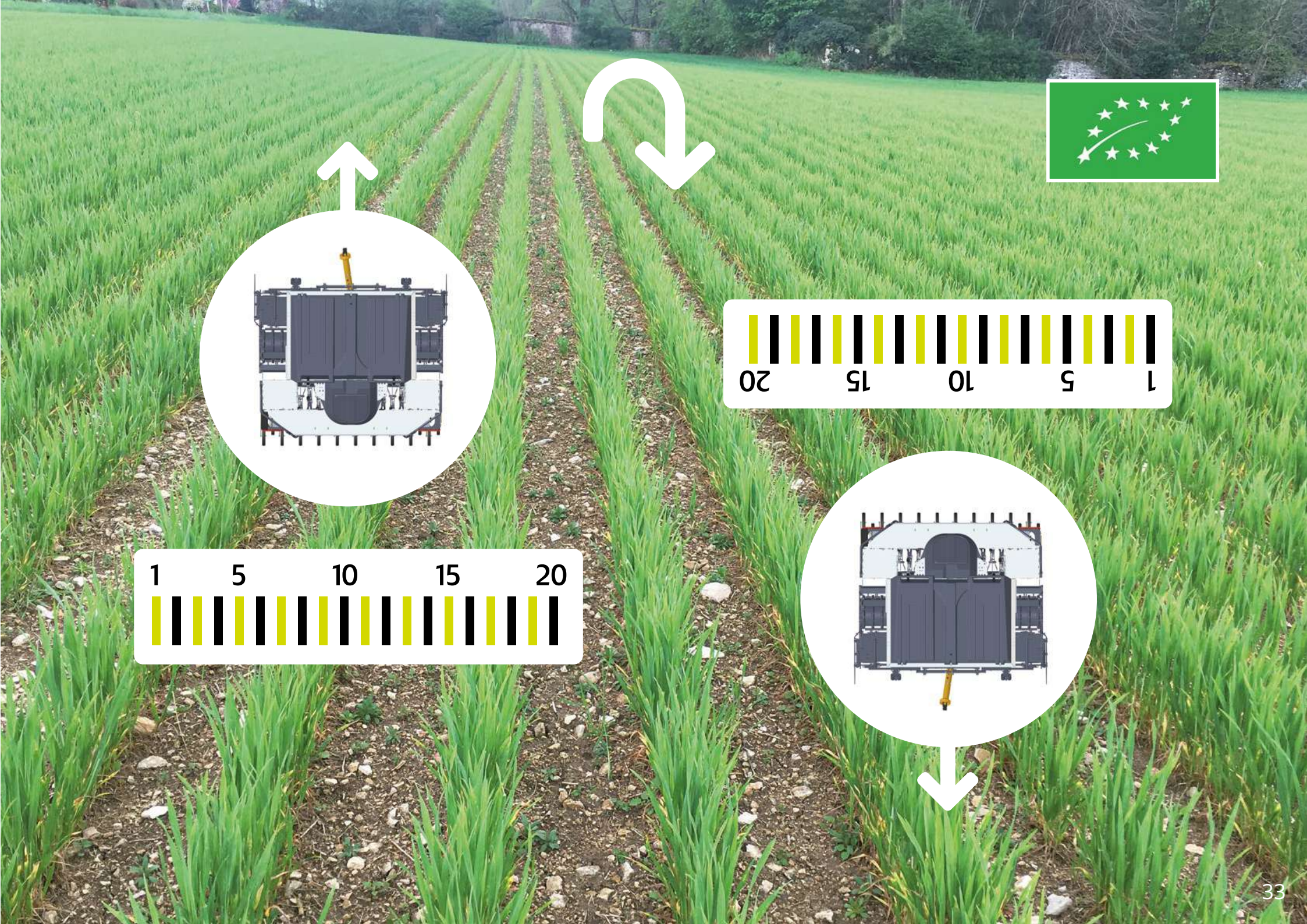



# TC-GEO Modulation







**TC-SC**  
Stop & Go













**SKY**  
AGRICULTURE

PROGRESS  
P20

P20



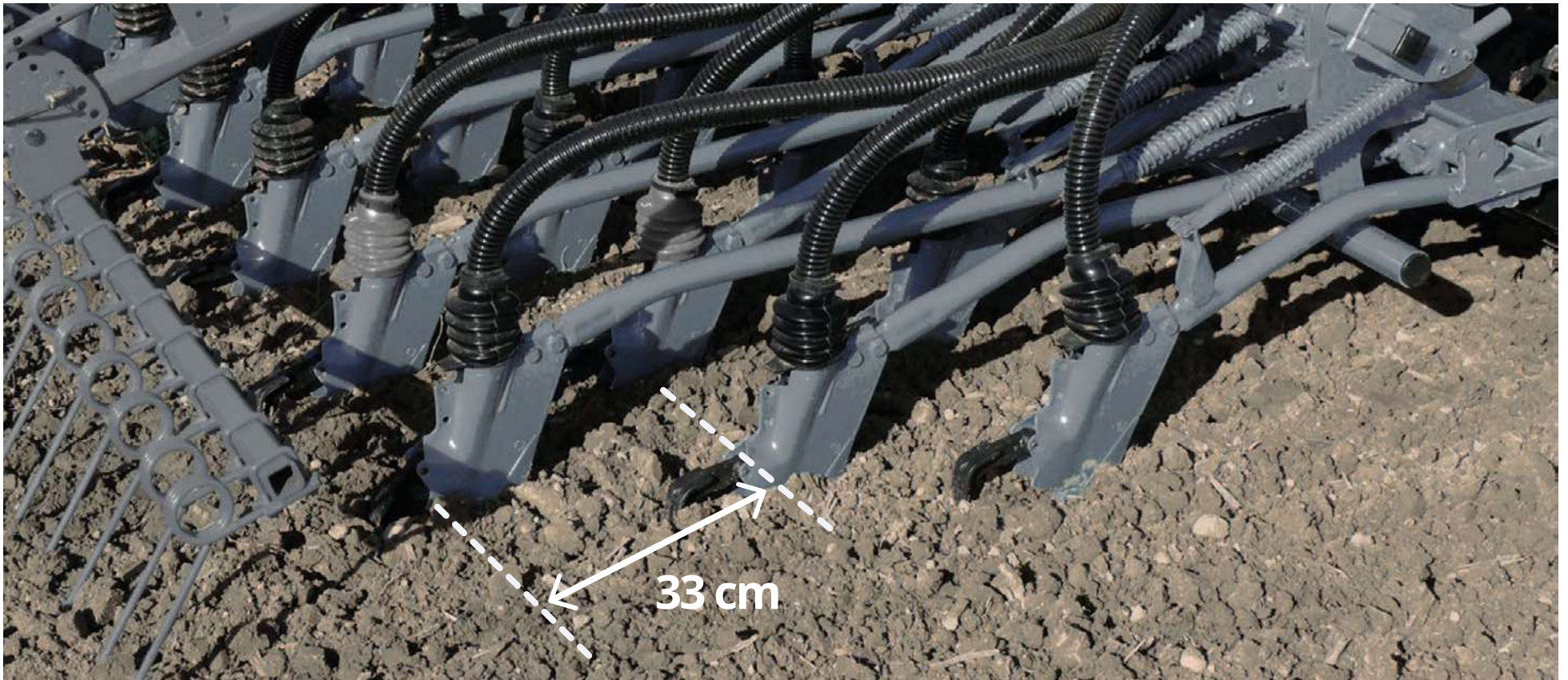
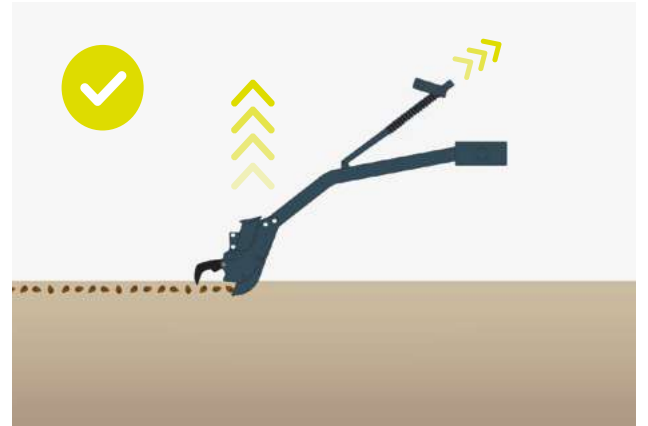
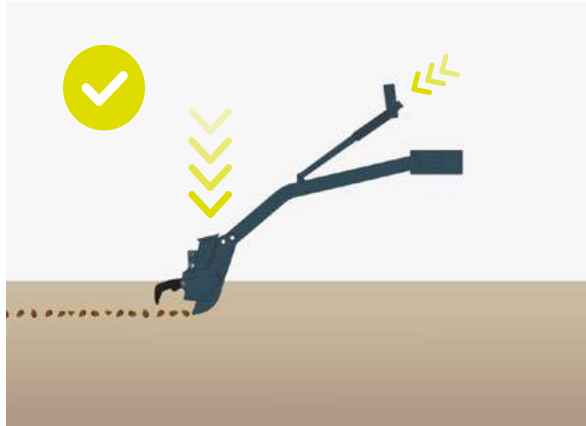
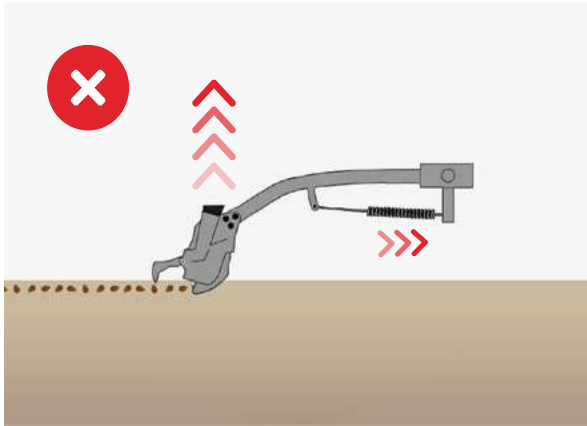





P30



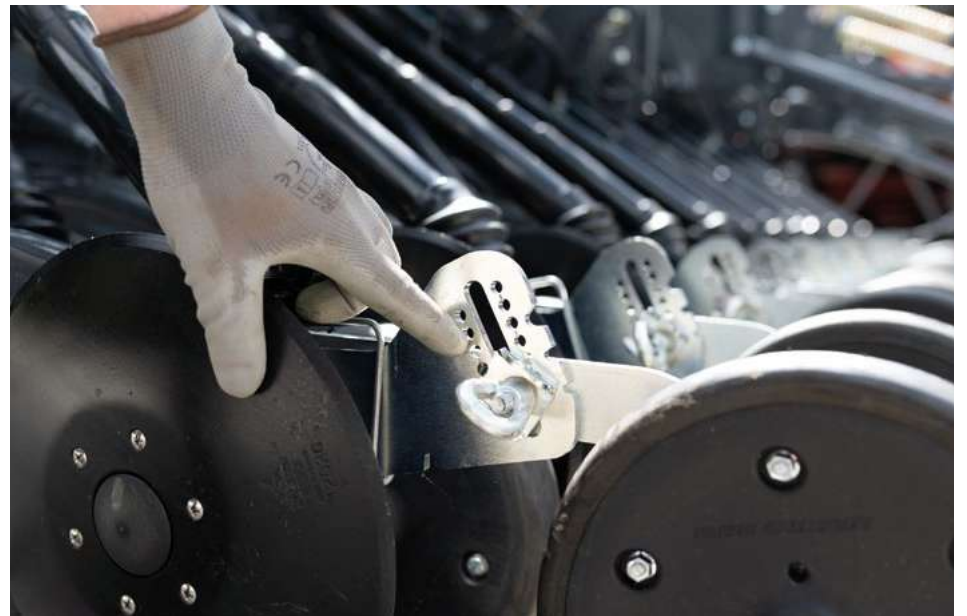
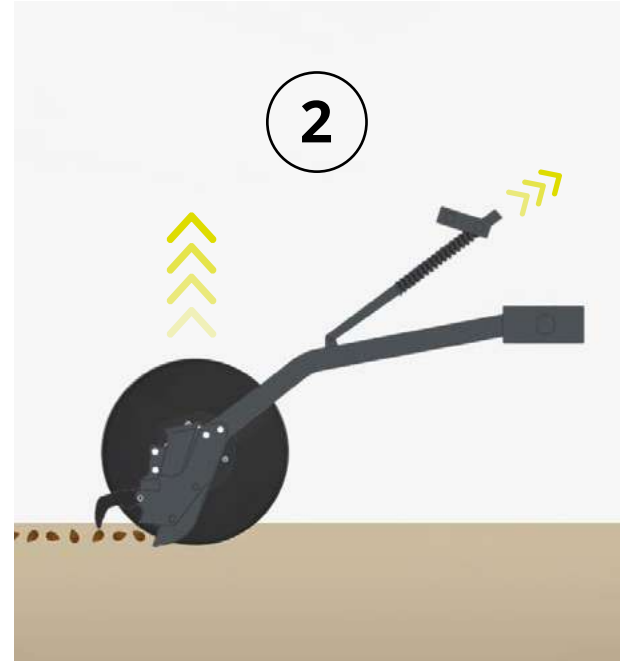
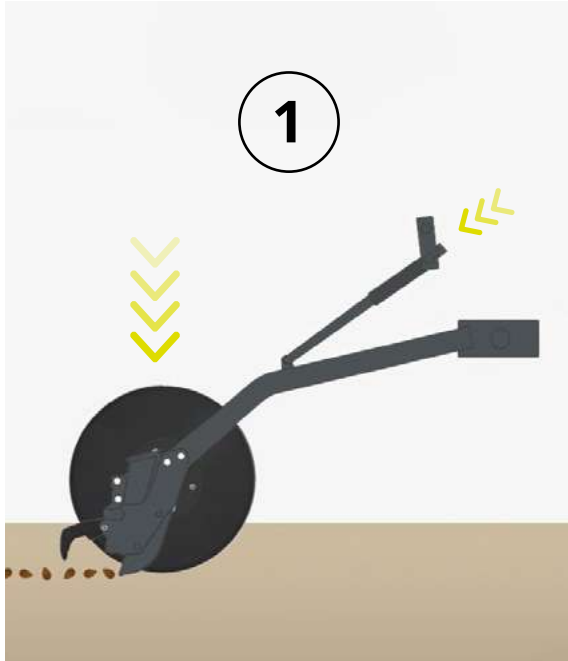





P50



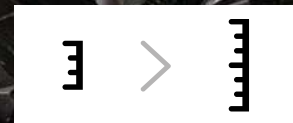
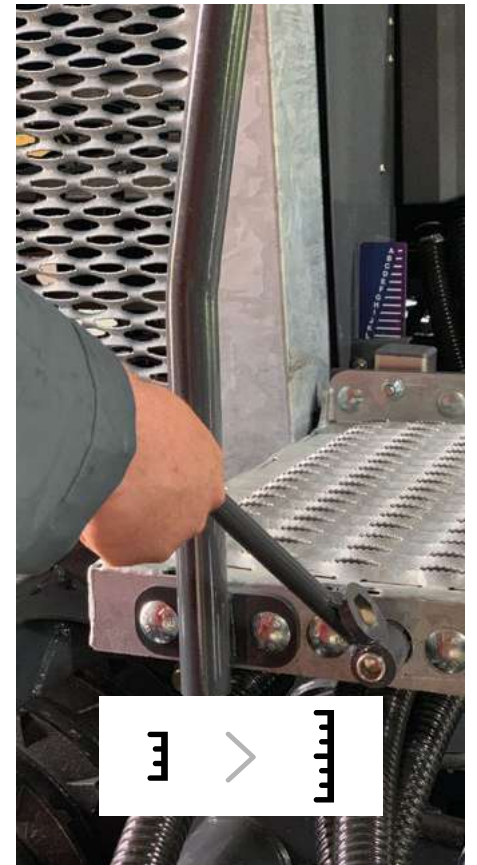
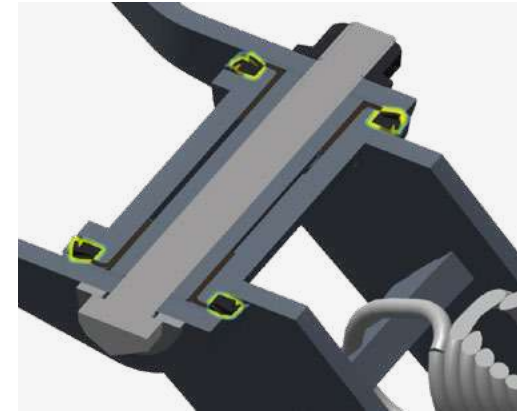
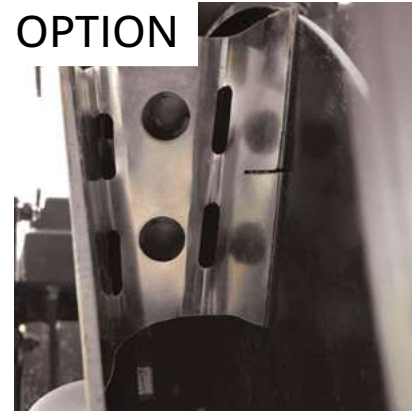





P100



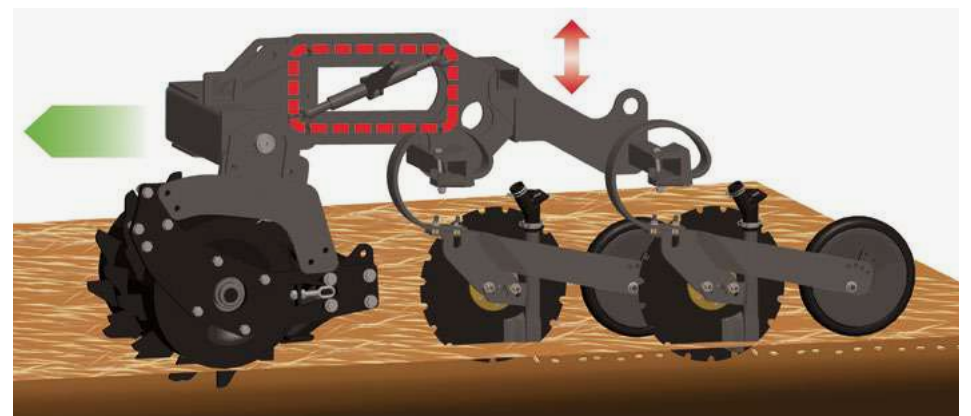
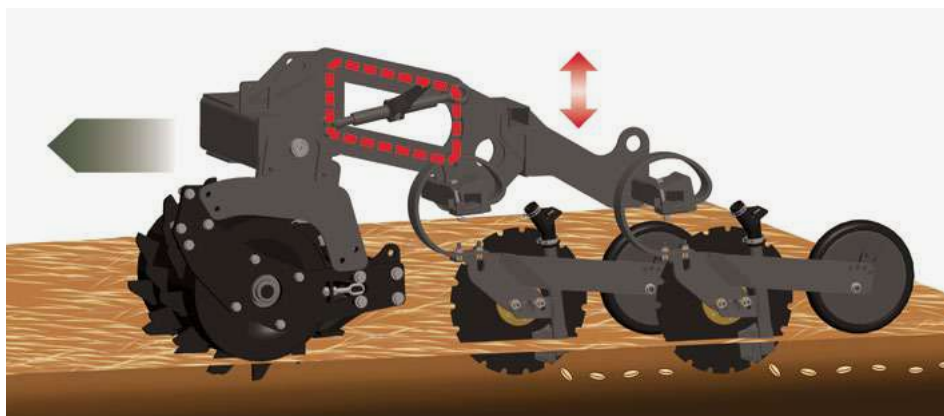
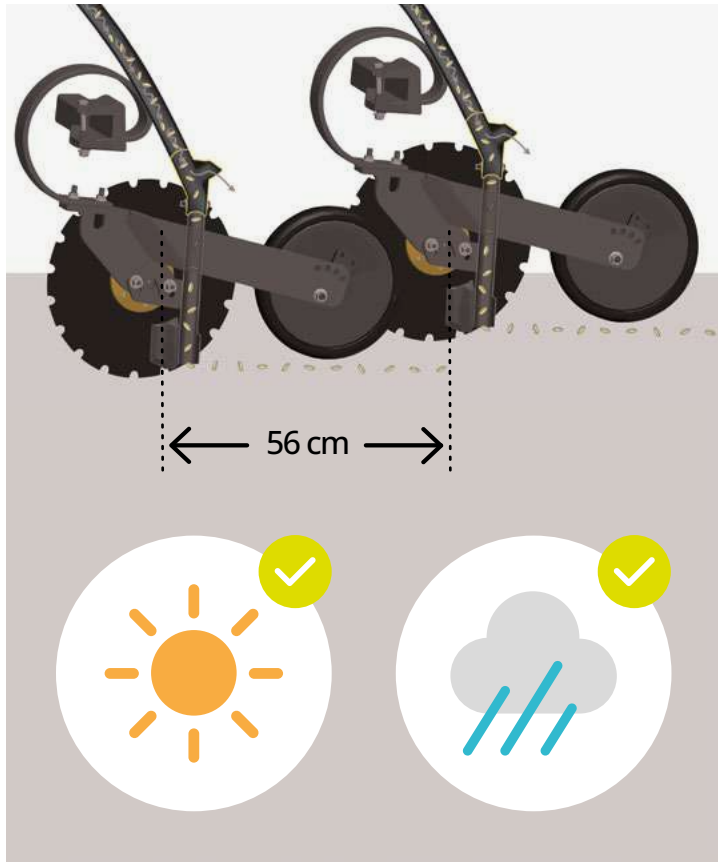



## PROGRESS M



## PROGRESS





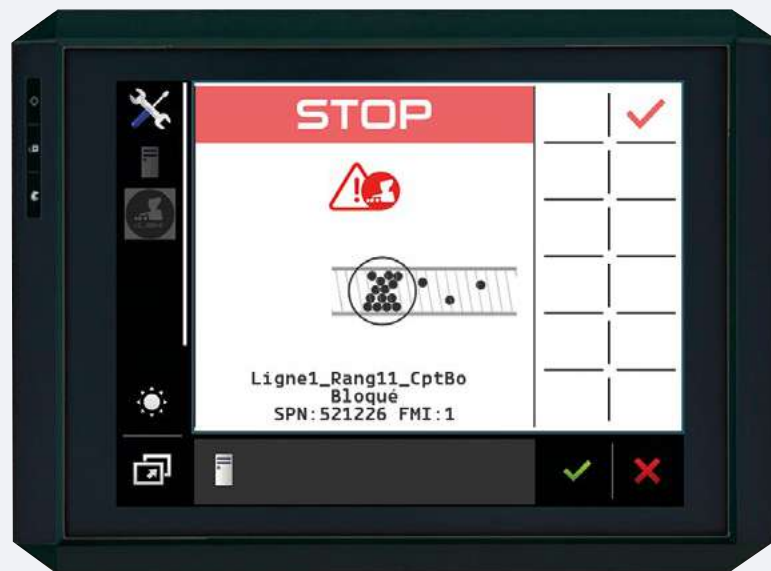
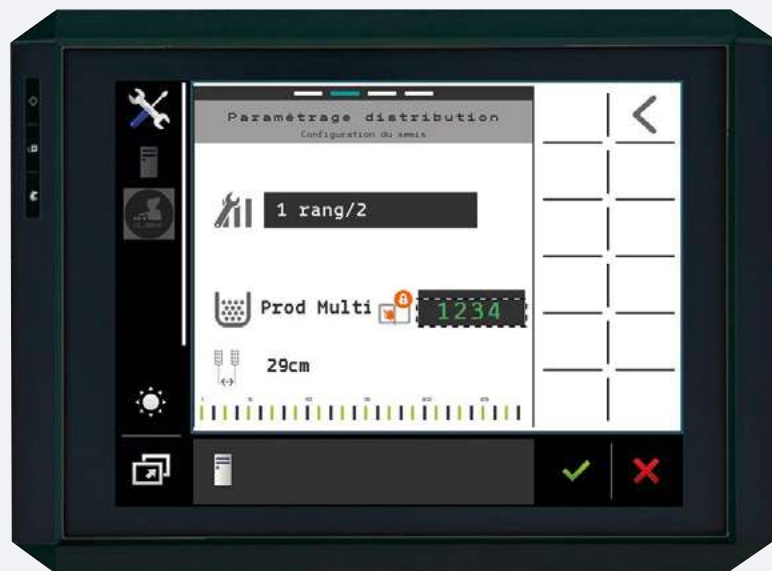





## OPTIONS **PROGRESS**

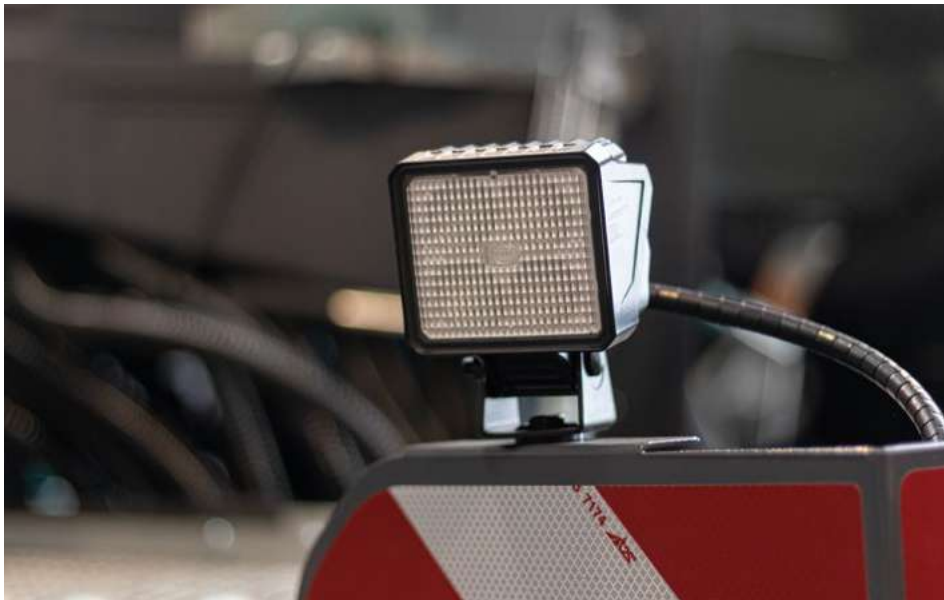















# HR



# XR

Type	160	190	220		300		
 (kg) Packer Ø550	1408	1700	1857	2041	1734	1937	2120
 (m)	3	3	3,5	4	3	3,5	4
 (CV)	160	190	220		300		
	12	12	14	16	12	14	16

Type	3	3,5	4
 (kg) Packer Ø550	1441	1620	1816
 (m)	3	3,5	4
 (CV)	150-210	175-240	220-300
	22	26	30

# PROGRESS







Type	1250L	1750L	1200L + 800L	
 (kg)	375	400	460	
 (m)	2,02	2,22	2,22	
 (m)	1,84 x 1,24		1,06 x 1,24	0,77 x 1,24

Type	P20						P50						P100		
 (m)	3	3,5		4		3	3,5		4		3	3,5	4		
	20	24	24	28	28	32	20	24	24	28	28	32	20	24	28
 (cm)	15	12,5	14,6	12,5	14,3	12,5	15	12,5	14,6	12,5	14,3	12	15	14,6	14,3
 (kg)	510	520	550	570	610	620	660	720	740	790	810	870	1080	1200	1330



# PROGRESS M



Type	P20		P30	
 (m)	3		3	
 (L)	1000		1000	
 (cm)	124x184		124x184	
 (cm)	189		189	
 (cm)	15	12,5	15	12,5
		20	24	20
 (kg)	730	765	790	840







**Châteaubourg**

P.A. de la Gaultière  
35220 Châteaubourg

**Fontenay**

21 Rue Jean Monnet  
28630 Fontenay-sur-Eure

**Carvin**

Rue du Pont de Grès  
62220 Carvin

**Osasco**

Via Garzigliana, 37  
10060 Osasco TO, Italie

**Ferme de la Conillais**

Saint-Émilien-de-Blain  
44130 Blain

📞 Tél : +33 (0)2 99 00 84 84

✉ contact@sky-agriculture.com

🌐 sky-agriculture.com